

AUSTIN UTILITIES

Electric Service Rules & Regulations



Revised: April 2018

Our mission is to offer utility products and services in a safe, reliable and responsible manner in order to enhance the quality of life in our community.

**AUSTIN UTILITIES
ELECTRIC SERVICE**

RULES AND REGULATIONS

Revised: April 2018

INTRODUCTION

Austin Utilities (here after referred to as AU) has assembled this booklet to assist its customers and their architects, engineers, or electrical contractors to plan for and obtain prompt and satisfactory electric service. The requirements herein supersede all previous publications of “Electric Service Rules and Regulations” issued by AU prior to this date and is subject to change without notice.

The information presented here is intended to supplement the requirements of the (NEC®) (NESC®) and all other applicable federal, or state, and municipal codes, regulations, laws and ordinances. It is always necessary to refer to and comply with such other codes, regulations, laws, and ordinances when planning, designing, and installing a new electrical service. Specific requirements of Austin Utilities do not intentionally conflict with any other requirements known to be in effect as of the publication date of this booklet. Any apparent conflicts of this nature should be brought to the attention of Austin Utilities for interpretation.

Power lines carry voltage that can cause shock, injury, or death.

Contact Austin Utilities for guarding when working around electric wires. Please notify Austin Utilities immediately if you find electric equipment damaged, open, or unlocked.

Caution: *Overhead wires and conductors are not insulated for protection from contact. Please exercise care when working near overhead facilities.*

Caution: *Stakes, flags or painted lines mark the locations of underground utilities. Please dig very carefully within 18” on each side of the markings.*

AU will be happy to confer with those customers desiring information concerning rates, services, etc., upon request by telephone or otherwise. Such requests should be directed to AU Customer Service Representatives (located at the Austin Utilities Office, 1908 14th Street NE, MN 55912 -- Phone 507-433-8886, Talk2AU@austinutilities.com).

AUSTIN UTILITIES
ELECTRIC SERVICE RULES & REGULATIONS

BOARD APPROVAL DATE: 04-10-2018

ISSUED DATE: 05-01-2018
EFFECTIVE DATE: 05-01-2018

SERVICE TERRITORY

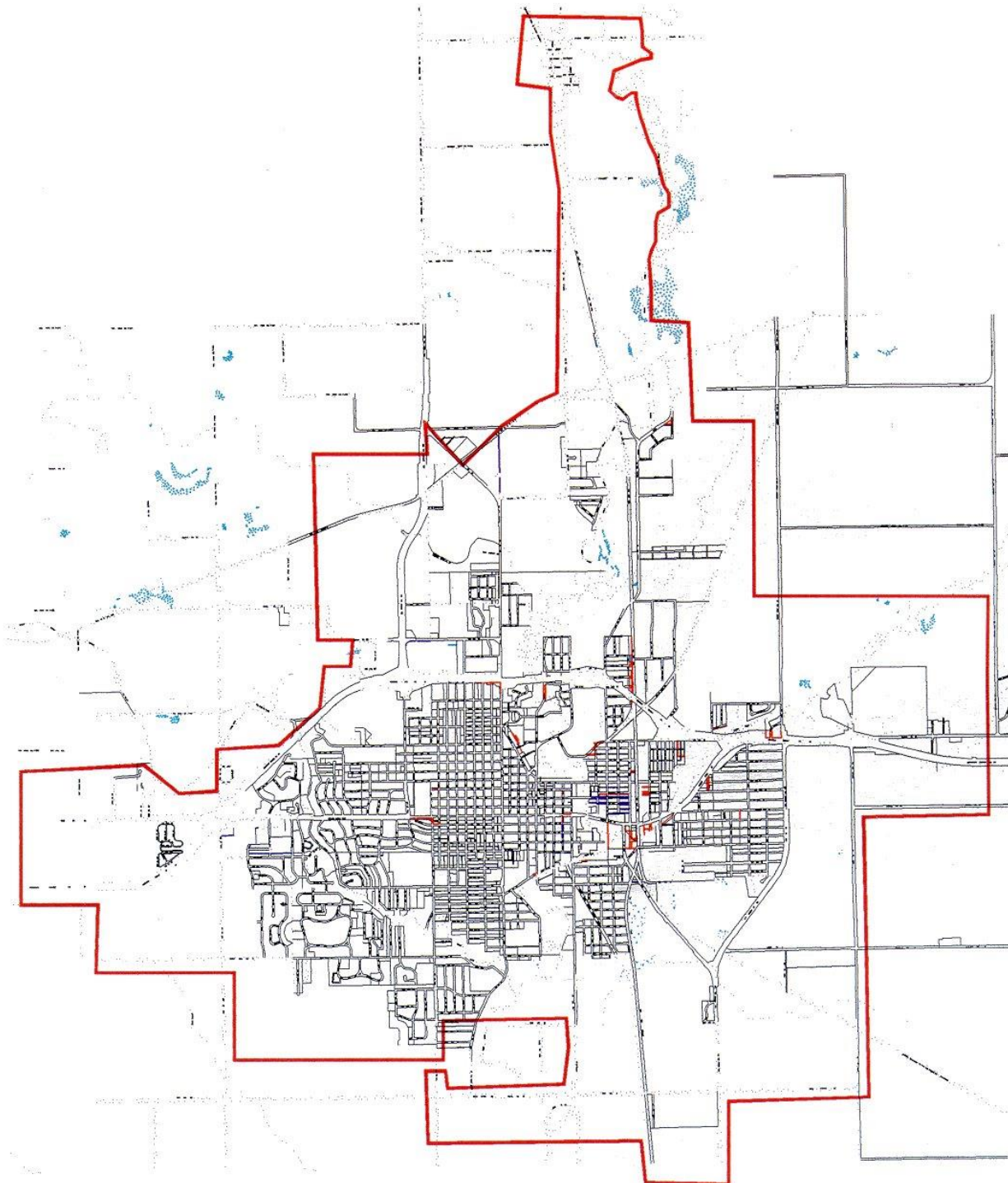

TABLE OF CONTENTS

		INTRODUCTION	1
		SERVICE TERRITORY	2
		TABLE OF CONTENTS	3
Section	100	DEFINITIONS	6
Section	200	GENERAL INFORMATION	10
	200	Electrical Regulations	10
	201	Service Jurisdiction	10
	202	Application for Service	10
	203	Ownership of Equipment	11
	204	Easements	12
	205	Inspection of Customer Facilities	13
	206	Service Connection, Disconnection, and Reconnection	14
	207	Liability	16
	208	Service Interruptions	16
	208.1	Unauthorized Use of Electricity	16
	209	Access	17
	210	Customer Responsibility	17
	211	Revisions of Requirements	17
	212	Damaged Utility Facilities	17
	213	House and Garage Moving/Wrecking	18
	214	Posting of Signs	18
	215	Tree Planting	18
	216	Tree Trimming Policy	19
	217	Meter tampering	19
	218	City Excavation License	19
Section	300	Blank	20
Section	400	STANDARD SERVICES	21
	401	General Characteristics	21
	402	Availability of Service	21
	403	Secondary Service Voltage	21
	404	Primary Service Voltages	22
Section	500	SPECIAL SERVICES	23
	502	Services for Unusual Load Characteristics	24
	503	Excess Facilities	25
	504	Redundant Facilities	25
	505	Relocation or Protection of AU Facilities	25
	506	Security Lighting	25
	507	Street Lights	26
	508	Rewiring Existing Facilities	26
Section	600	METERS	27
	601	Responsibilities for Providing Metering Equip.	27
	602	Location of Meters	27
	603	Grouped Meters	29

	604	Meter Identification	30
	605	Meter Mounting	30
	606	Meter Connections	31
	607	Wiring Restrictions on Meters and Metering Sets	31
	608	Meter Testing	32
	609	Meter Seals	33
	610	Advanced Meter Infrastructure (AMI)	33
	611	Instrument Transformer Installation	34
	612	Self-Contained Metering for Commercial Installations	36
	613	Master Metering	36
	614	Approved Sockets	37
	615	Socket Bypass Required	38
	616	Service at 480 Volts	38
	617	Location of High-Leg in Meter Socket on 240/120 Volt, 3-Phase Services	38
	618	Stacked Meter Sockets	39
	619	Removing Austin Utilities Seals and Meters	39
	620	Customer Generation	39
	621	Proper Grounding	39
	622	Customer Disconnect Switch	40
	623	Special Sockets	40
	624	AU Owned Equipment	40
	625	Temporary Removal of Meter Sockets for Siding Installation / Repair	40
	626	Redistribution of Energy	41
	627	Arc Flash	41
	628	Load Shedding and Kyz Customer Connections	41
	629	Load Management Metering	41
	630	Clearances from Gas Meters	42
	631	Totalized Metering	42
Section	700	CUSTOMER UTILIZATION EQUIPMENT	43
	701	Protection of Customer Equipment	43
	702	Motor Starting Currents	44
	703	Blank	44
	704	Tankless Water Heaters	44
	705	Electric Vehicle Charging Stations	45
	706	Power Factor	45
	707	Fault Currents	45
	708	Arc Flash	46
	709	Wiring Adequacy	46
	710	Customer-Owned Generating Equipment	46
	711	Energy Conservation	47
	712	Customer's Obligations	47

	713	Carrier Current - Customer Responsibilities and Limitations	49
	714	Thawing Water Services	49
Section	800	OVERHEAD SECONDARY SERVICES	50
	801	Maximum Transformer Size	50
	802	Service Drop Conductors	50
	803	Overhead Clearances	51
	804	Point of Attachment	51
	805	Service Entrance	52
Section	900	UNDERGROUND SERVICES	53
	901	Residential Services	53
	902	Underground in Residential Developments	53
	903	Underground Service Construction	55
	904	Underground Service to Commercial and Industrial Customers	56
	905	Secondary Connection Cabinets	58
	906	Transformer Clearances	58
	907	Rock and Winter Installation	59
	908	Installation in Rocky Soils or Poor Backfill	59
	909	Total Undergrounding	60
	910	Service Grounding	60
	911	Service Relocation	60
	912	Repair of Underground Services	61
Section	1000	SERVICE EXTENSION	62
	1001	Objectives	62
	1002	Policy Content	62
	1003	Construction Allowance – New Customer	64
	1004	Construction Allowance – Existing Customer	64
Section	1100	Blank	65
Section	1200	UNDERGROUND LOCATIONS	66
	1201	One-Call	66
	1202	Excavation	66
	1203	Requests	66
	1204	Contact with Electric Cable	67
	1205	Damages	67
Section	1300	ELECTRIC WELDERS	68
Section	1400	POLE ATTACHMENT	69
Section	1500	EXHIBITS	70

DEFINITIONS

Application for Service: The agreement or contract between AU and the Customer under which electric service is supplied and taken.

Accessible: Capable of being reached quickly for operation, renewal, or inspections, without requiring those to whom ready access is requisite to climb over or remove obstacles or to resort to portable ladders, chairs, etc.

Agreement for Electric Distribution Service Extension: The agreement or contract between AU and the land owner/developer under which the land owner/developer agrees to provide easements and to contribute to the cost for the extension of utility services.

Approved: Acceptable to the authority having jurisdiction.

Connected Load: The combined manufacturer's rated capacity of all motors and other electric energy consuming devices on the Customer's premises which may, at the will of the Customer, be operated with the electric energy to be supplied from the service of AU.

Contractor: Licensed individual or company who performs work for the Customer or AU.

Current Transformer: An instrument transformer designed for the measurement or control of current.

Customer: Any individual, partnership, corporation, or other legal entity now being served or to be served, using the electric service of AU at any specified location.

Customer's Service Equipment: The necessary equipment and accessories, located near the point of entrance of supply conductors to a building, which constitute the main control and means of disconnecting the supply to that building. This equipment usually consists of a circuit breaker or a switch and fuses.

Disconnection Means: A device, or group of devices, or other means by which the conductors of a circuit can be disconnected from their source of supply.

Distribution Lines: AU lines located along streets, alleys, highways, or easements on private property, when used or intended for use for general distribution of electric service to customers.

Dwelling:

Dwelling Unit: One or more rooms for the use of one or more persons as a housekeeping unit with space for eating, living and sleeping, and permanent provisions for cooking and sanitation.

Multi-Family Dwelling: A building containing two or more dwelling units.

Single-Family Dwelling: A building consisting solely of one dwelling unit.

Electric Service: The availability of electric power and energy, regardless of whether any electric power and energy is actually used. The supplying of electric service by AU consists of the maintaining, at the point of delivery, approximately the agreed voltage, phase and frequency by means of facilities adequate for carrying the load which AU is thereby obligated to supply by reason of the known requirements.

Excess Facilities: In those instances where AU provides distribution and/or metering facilities as the customer's request, in excess of the facilities AU deems necessary to supply service to the customer.

Fault Current: The current that will flow through the system to a point where a piece or a conductor has failed, such as bare conductors touching together or a bare conductor touching a ground point.

Frost (Frozen Ground): A condition where the water contained in the ground freezes resulting in additional difficulty and expense in excavation.

Instrument transformer: A transformer that reproduces in its secondary circuit, the voltage and current proportional to its primary current.

Instrument Transformer Cabinet: A cabinet installed and owned by the customer meeting AU requirements, designed for housing instrument transformers used for metering.

Master Metering: Metering configuration where a single meter (master meter) measures the consumption of a building and then sub meters on the customer side of the Master Meter measure the consumption of the individual load or groups of loads.

Meter / Meter Set: An instrument or instruments, together with auxiliary equipment for measuring the electric power and energy supplied to a customer.

National Electrical Code (NEC®): The current edition of the National Electrical Code (NEC®) as issued by the National Fire Protection Association (NFPA No. 70).

National Electric Safety Code (NESC®): The current edition of the (NESC®) as issued by the Institute of Electrical and Electronics Engineers (IEEE C2), American National Standards Institute (ANSI C2).

Overhead Distribution Areas: The area or areas served by the AU overhead distribution system as differentiated from the underground systems.

Points of Delivery: The point where the electric energy first leaves the line or apparatus owned by AU and enters the line or apparatus owned by the customer. This is not necessarily the point of location of AU meter.

Rate Schedule Classification: The classification of the use of electricity into categories considering the amount of power supplied and the purpose of its use.

Secondary Terminal: The secondary side of a pad mounted transformer, a secondary terminal box at the base of a riser pole, or a secondary junction box, whichever is designated by AU.

Service: The conductors and equipment for delivering energy from the AU distribution system to the wiring system of the customer.

Service Drop: The overhead service conductors from the last pole or other aerial support to and including the splices, if any, connecting to the service-entrance conductors at the building or other structure.

Service Entrance Conductors, Overhead System: The service conductors between the terminals of the service equipment and a point usually outside the building, clear of the building walls, where joined by a tap or splice to the service drop.

Service Entrance Conductors, Underground System: The service conductors between the terminals of the service equipment and the point of connection to the service lateral.

Service Equipment: The necessary equipment, usually consisting of a circuit breaker or switch and fuses, and their accessories, located near the point of entrance of supply conductors to a building or other structure, or an otherwise defined area, and intended to constitute the main control and means of cutoff of the supply.

Service Lateral: The underground service conductors from the AU distribution system, including any risers at a pole or other structure or from transformers, to the first point of connection with the service entrance conductors in a terminal box or meter or other enclosures with adequate space, inside or outside the building wall. Where there is no terminal box, meter, or other enclosure with adequate space, the point of connection shall be considered to be the point of entrance of the service conductors into the building.

Type of Service: The characteristics of electric service described in terms of frequency, phase, nominal system voltage, and number of wires.

Primary Service: Any type of service with a nominal voltage greater than 600 volts.

Secondary Service: Any type of service with a nominal voltage less than or equal to 600 volts.

Underground Residential Distribution (URD) Areas: Those residential subdivisions or other specified areas within which all customers are served by underground distribution lines.

Utility: For the purpose of this document any public, city, or city-franchised organization that furnishes electric service.

Voltage (Of a Circuit): The greatest root-mean-square (effective) difference of potential between any two conductors of the circuit concerned.

Voltage, Nominal: The value, expressed in volts, which is assigned to a circuit or system for the purpose of conveniently designating its voltage class (as 120/240, 480Y/277, 600, etc.). The actual voltage at which a circuit operates can vary from the nominal within a range that permits satisfactory operation of equipment.

Voltage to Ground: For grounded circuits, the voltage between the given conductor and that point or conductor of the circuit that is grounded; for underground circuits, the greatest voltage between the given conductor and any other conductor of the circuit.

SECTION 200

GENERAL INFORMATION

200 ELECTRICAL REGULATIONS

200.1 General - All electrical wiring, apparatus, and equipment for electric light, heat, and power, shall comply with rules and regulations of AU, and the latest edition of the (NEC®) and (NESC®). This includes compliance with the Railroad and Warehouse Commission, the Commissioner of Insurance, or the Industrial Commission, as applicable, the Minnesota Building Code and any other code as adopted by a governmental agency of equipment. Deviations from the regulations may be made only at the discretion, and with the approval of, the General Manager or Director of AU.

200.2 Purpose - The primary purpose of these regulations is the practical safeguarding of persons, of buildings and their contents from hazards arising from the use of electricity for light, heat, power, radio and television signaling, and other safeguards to life and property. The City of Austin has adopted the current (NEC®) Standards of the National Board of Fire Underwriters as approved by the American Standards Association as minimum requirements for electrical wiring and installations. Other requirements, as may be adopted by the Utilities Board, are included herein and shall be complied with by all licensed electricians working within the jurisdiction of the AU service area.

201 SERVICE JURISDICTION

AU has been established by the City of Austin for the purpose of providing electricity to the residents of the City. AU also provides electricity to residents outside of the City limits but within the service area boundaries established by the State of Minnesota. Service will be provided to all eligible applicants only when all applications, agreements, easements, deposits, payments, and other required information have been provided to AU.

202 APPLICATION FOR SERVICE

Application for new, additional, or temporary electric service must be made by the Customer, or a designated representative, to Austin Utilities Office, 1908 14th Street NE, in person, or email to Talk2AU@austinutilities.com.. At the time of application, the Customer

is required to provide, information relating to the service request, including the following:

- (1) Exact location of premises to be served, including building street address, apartment or unit number if applicable, lot and block numbers and name of subdivision.
- (2) The type of service desired (e.g. temporary, permanent, residential, subdivision, dwelling unit, commercial, industrial, rewire, etc.).
- (3) The approximate date that electric service is required.
- (4) The name, address, and telephone number of the Customer's designated representative who will be responsible for working with AU representatives in providing the electric service (e.g. customer employee, engineer, and contractor).
- (5) Commercial Service - Electrical Load Data Statement specifying the type of service required by the Customer and expected magnitudes of connected and peak load. Additional data in the form of construction drawings and the proposed service entrance may also be necessary for AU to adequately determine the capacity and arrangement of service to the Customer. This statement must be received by AU before a work order for the project can be issued and the necessary planning and design of the project can begin.

AU should be advised of planning installations as early as possible so that details for furnishing service may be arranged and construction completed by the desired date. See Section 206 for connections and disconnections to existing services.

203 OWNERSHIP OF EQUIPMENT

203.1 AU-Owned Equipment - The meter and associated metering equipment furnished or installed by AU are the property of AU.

203.1 (a) Overhead Service—In addition to the metering equipment, the overhead service drop installed by AU is the property of AU.

203.1 (b) Underground Service—In addition to the metering equipment, all equipment up to, and including the designated secondary terminal installed by AU is the property of AU. (The

secondary terminal could be the secondary terminal of a pad-mounted transformer, or a secondary junction box.) Unless service is taken at primary voltage or otherwise specified by written agreement, all conductors and equipment operating at nominal voltages in excess of 600V are the property of AU.

203.2 Customer-Owned Equipment - The meter socket, instrument transformer compartment (if required, see Section 610), the service entrance conductors and conduit from the meter socket to the service entrance disconnect, the service entrance switch or circuit breaker and the service entrance ground equipment and the concrete transformer pad and grounding grid are the property of the Customer.

203.2 (a) Overhead Service—In addition to the equipment on the Customer side of the meter socket, the service drop wire holder or bracket, the weather head and either the service mast and conduit with entrance wires or the service entrance cable with watertight connection to the meter socket are the property of the Customer.

203.2 (b) Underground Service—In addition to the equipment on the Customer side of the meter, all conduit and cable required to extend the secondary service lateral from AU secondary terminals to the meter socket are the property of the Customer.

The Customer and AU are responsible for the installation, maintenance, repair, and replacement of the electric service equipment which each owns.

204 EASEMENTS

Whenever any AU-owned underground and/or overhead material and equipment is located on or above the Customer's property, the Customer shall grant an easement to AU to the extent, which AU deems necessary. All utility easements required by AU are to be granted by the Customer at no cost to AU. (This does not include secondary service drops or service laterals.) The Customer must provide a legal description by a Registered Land Surveyor. The easement will be signed and recorded by AU.

205 INSPECTION OF CUSTOMER'S FACILITIES

205.1 - As a minimum, wiring and electrical equipment of the Customer shall be installed in accordance with the latest edition of the (NEC®)

205.2 - Customers living within the service area of Austin Service Territory and requesting service from AU must have their wiring inspected and approved by an AU representative and by an authorized State of Minnesota inspector. AU will not make connection until a satisfactory utility inspection is complete and meter socket appropriately marked. AU will make connection before authorization from the state inspector only if the master electrician who installed or supervised the installation agrees in writing to be responsible for said wiring until such time that it can be inspected and approved by the authorized State of Minnesota inspector. "Request for Electrical Inspection" (white form).

205.3 Inspection Fees – AU service connection and inspection fees shall be a minimum payment of fifty dollars (\$50.00)

205.4 Underground Service Installation - Electrical contractors are requested to contact AU when they call for inspection of residential service conductors with the trench open. If inspection points are used rather than an open trench, the contractor is requested to have one of the inspection points by the AU point of service. This is done to facilitate prompt installation of cable into the secondary pedestal or transformer and avoid damage to the service conductors, especially for fall and winter installations.

205.5 REI - Any electrical wiring within the service area, (AU requires a "Request for Electric Inspection" (REI) issued and obtained by the licensed Master Electrician from the agency so designated by the AU. This will be the State of Minnesota Electrical Inspector.

205.6 Connection Refusal - Refusal to permit AU, the inspector and State of Minnesota to properly examine the wiring will be cause for AU to refuse to connect the premises to electrical service or to discontinue the existing service until such time as the wiring may be inspected. Service connection may also be refused if the wiring is not completed in conformance with the Electric Code (NEC®) as determined by the electrical inspector.

SERVICE CONNECTION, DISCONNECTION AND RECONNECTION

After the Customer's installation has been inspected and approved by the proper authority, a meter will be installed by AU and the electric service made available provided that all applications, agreements, and deposits have been submitted by the Customer and approved by AU. Written or email inspection notices must be received by AU no later than 3:00 p.m. of the day preceding the date that connection is desired (weekends and holidays excluded). Under special circumstances, verbal inspections will be accepted as long as written inspection documentation is submitted within 24 hours thereafter.

206.1 Resumption of Electric Service Fee – AU resumption of electric service at customer's request during regular business hour is \$75.00. There will be charges (fees) for connection and reconnection of service during normal working hours. If connection must be made outside of normal working hours at the request of the customer, a special connection charge (fee) will be assessed. After hours reconnect fee is \$250 weekdays and Saturdays and \$500 on Sundays and Holidays.

Customer requests for disconnection or reconnection of existing services must be received by AU at least 48 hours in advance of the desired time of disconnection or reconnection (weekends, and holidays excluded). For the mutual protection of the Customer and AU, only authorized employees of AU are permitted to set and remove meters, or to make and energize or break and de-energize the connection between AU's service drop and secondary terminals, or the Customer's service entrance conductors and secondary laterals.

206.2 – Suspension of electric service for non-payment of bills, during regular business hours is \$ 50.00 dollars for suspension of service. A schedule of fees is available from AU' office.

206.3 - When it becomes necessary to disconnect a customer for non-payment of bills or for any other reason, with or without notice as defined, or in the AU operations and maintenance procedures or other applicable law or regulation; it shall be the AU policy to:

206.3 (a) - Any electric service which has been disconnected for three (3) months or longer to a property wherein any other service has been disconnected, and/or is in a state of disrepair shall be brought to the attention of the Electric Department, so that an evaluation can be made and judgment rendered relative to whether

the Director of the Electric Department or the Supervisor of the Electric Department will/or will not, reinstate the service until after the service in question has been inspected by the State Electrical Inspector, along with all necessary "Requests for Electrical Inspection" (White form) and paper work completed.

206.3 (b) - Such disconnection(s) shall remain intact until corrections are completed by the owner of the property, has been inspected by the State Electrical Inspector and authorized by the Electric Department.

206.4 Inactive Meters and Service Lines - AU reserves the right to terminate the service by disconnecting the service line at the pole on any property that it deems has been inactive, and/or that is in such a state of disrepair so as not to properly protect the AU service and/or property, or is deemed a danger, or a hazard to the public. If the property remains vacant for 12 months, disconnect at the pole shall be automatic. The AU Business Office will mail notification of the impending termination to the property owner at the last known address of the owner, as is on file in the AU Business Office. Ten days shall be allowed from date of notification to time of termination.

If a building is scheduled to be torn down, the demolition contractor shall notify AU for a service disconnect one week prior to wrecking the building. The demolition contractor shall furnish the required information at the AU Business Office. AU will disconnect service at no cost to the demolition contractor.

If at some future time the owner at the location requires service, the owner shall be required to make a new "APPLICATION FOR SERVICE", pay any and all liens or amounts encumbered by AU and/or any outstanding AU charges before an account will be reactivated.

206.5 Fire Disconnect & Reconnect

- 1) Upon request by the Austin Fire Department, AU will dispatch the appropriate crews to disconnect electric utility services at the meter or as otherwise proper for the circumstances.
- 2) Service will be restored at the request of the customer PROVIDED:

Restoration is approved verbally by Fire Department AND,

Restoration is approved verbally by the AU Gas Department where gas services exist, AND,

On site authorization is provided by a Journeyman Electrician who has inspected, and repaired if necessary, premise wiring. This electrician shall be identified and shall furnish assurance that a "Request for Electrical Inspection" (White Form) will be provided to AU by a licensed master electrician confirming the request for restored service.

- 3) In no event will service be restored if damage to AU distribution outside the premises presents a hazard to persons or property.

207 LIABILITY

AU does not engage in the practice of doing interior wiring on Customer's premises except for the installation and maintenance of its own property, and therefore, is not responsible for service beyond the point of delivery. AU shall not be liable for damage to any Customer or to any third party resulting from the use of the service or from the presence of AU appliances or equipment on the Customer's premises.

The Customer is solely responsible for any accidents, fires, or failures resulting from the condition and use of his wiring installation or equipment.

208 SERVICE INTERRUPTIONS

AU reserves the right to interrupt service at any time. Interruptions for maintenance and system improvements will be prearranged and advance notice will be given to the Customer whenever practical.

AU will not be responsible for consequential damages resulting from service interruptions or fluctuations outside its control or from operations in response to abnormal system conditions. Customers requiring service reliability and/or stability exceeding AU' normal service should consider uninterruptible power supplies, isolation transformers, power conditioners, redundant services, or other options to provide the level of service needed. AU staff is available to discuss such needs.

208.1 Unauthorized Use of Electricity

208.1 (a) - AU is a public utility in the business of supplying electric service to ultimate consumers. Electric service is furnished for the use of the Customer only, and the Customer shall not resell nor permit other persons to use it.

208.1 (b) - Sub-metering for resale of electricity is an unauthorized use of electrical service. The Customer shall not sub meter any portion of such service in any manner for resale. Please see Section 613.3

209 ACCESS

Employees of AU shall have access at all reasonable hours to meters, service connections and other property owned by it which may be located on customer's property. Access shall be provided for purposes of installation, maintenance, reading, checking, or removal if necessary. Failure to provide access shall result in termination of service until it has been provided. It shall also be a requirement that the electric meter shall be relocated outside of the building at the customer's cost before service will be restored.

210 CUSTOMER RESPONSIBILITY

Failure of the Customer to notify AU in a timely manner of any planned alteration to electric service facilities or increased electrical load, and failure to comply with AU' published rules, regulations, and rate schedules may result in delayed connections, interruption of service, or damage to equipment, for which AU disclaims all responsibility.

211 REVISIONS OF REQUIREMENTS

All requirements stated or implied herein are subject to change at any time without prior notice. All revisions can be obtained from the AU' office.

212 DAMAGED UTILITY FACILITIES

At any time any segment of our facilities to include such things as poles, meters, or any other parts of our system is damaged from any causes other than what is considered an "Act of God", or from damage caused by our own system, AU shall be reimbursed for our costs. This cost should cover the full extent of the damages including labor involved in the repair, as well as material used, as well as any meters involved.

212.1 Cutting of Service Wires - No service shall be cut at any time by the customer or contractor, and he **shall not break the seal** or remove the meter for any reason. AU must be notified, and they will

make any adjustments necessary. If this rule is not complied with, suitable penalties shall be imposed on the property owner.

213 HOUSE AND GARAGE MOVING/WRECKING

Please refer to AU “Miscellaneous Policies and Procedures.”

An application for a House/Garage Moving Permit with the City of Austin will be used. The applicant will apply with the City of Austin. The city has 72 hours to approve or disapprove this application. AU requires the customer to provide AU with house/garage – moving/wrecking notification. AU services must be disconnected as specified in Section 206.

The Electric Department will provide the cost and the applicant will be required to make payment before the house or garage can be moved. The minimum charge (fee) of \$1,000 will be required for all houses taller than 16 feet when loaded on trailer.

The houses all vary in height, depending on the route selected, each move impacts our customers to a varying degree. The Electric Department will work closely with the movers in selecting a route that will have the least impact on our customers in terms of the number of customers and the duration of the outages. The Electric Department may require the roof of the house be removed for any house greater than 24 feet running height when loaded on trailer. AU requires two weeks notification prior to moving date. A \$500.00 fee will be applied if date is rescheduled in less than 24-hours of date of move.

214 POSTING OF SIGNS ON UTILITY POLES

Attaching or hanging signs, posters, or other items require approval from AU. Special permission will be granted on a case-by case basis.

215 TREE PLANTING

If you plan to plant a tree at your expense near power lines, it is requested that you follow these guidelines:

- Please plant the tree no closer than 15 feet from under overhead electric wires to prevent electric outage problems in the future. This is also required by many of the utility easement terms.

- It is requested that a shorter variety of tree be planted in the vicinity of the power lines. The AU office at 507-433-8886 can assist you in tree variety information.
- Call Gopher State One-Call before digging at 1-800-252-1166.

216 TREE TRIMMING POLICY

AU easement rights allow for the construction, operation, and maintenance of its lines. This includes the right to enter the easement area to remove or trim trees and to remove or trim trees adjacent to the right-of-way that threaten the line due to their height or condition. AU will take reasonable precautions to avoid damage to fences, crops, and other private property.

For reliability and safety, we strive to have our entire system trimmed every three to four years by rotation of affected areas. On all utility lines, we prune to provide ten feet of side clearance and no overhang dependent upon species. Work is based on OSHA 1910.269 requiring anyone trimming within ten feet of an energized conductor be trained in live line trimming procedures. In addition, we remove diseased, weakened, or leaning trees that pose a risk to our system or threaten to cause safety problems. Secondary service and street light wires are cleared if they are being pushed down, up, or out.

The effected customers will be contacted via door hangers in advance and not later than the 24 hour prior to tree trimming work. The door hanger will include a local contact number so details of the work can be discussed.

217 METER TAMPERING

Austin Utility's meter tampering is a \$500.00 civil fine. The customer has thirty (30) days to pay the fine or to appeal it. After thirty (30) days the utility service may be suspended. The civil fine is in addition to criminal charges and penalties or charges under Sections 208.1 and Section 609.

218 CITY EXCAVATION LICENSE

AU requires all excavation contractors be licensed with the City of Austin. Application and license fees can be made through City Engineers' Office at 507-437-9950

SECTION 300

This section has been intentionally left blank.

SECTION 400

STANDARD SERVICES

401 GENERAL CHARACTERISTICS

This section describes the types of services offered to Customers under AU Standard Rate Schedules. Electric service supplied by AU is alternating current having a nominal frequency of 60 Hertz (cycles per second).

402 AVAILABILITY OF SERVICE

Although the types of service listed below are generally available through the area served by AU, service of the type requested by a Customer may not be available at the location where such service is desired, and in certain cases may be available only through special contractual arrangements and at the expense of the Customer. **Each Customer will generally be allowed only one type of service and one point of connection for each location. For redundant services, see Section 503.**

403 SECONDARY SERVICE VOLTAGE

The following types of secondary service are generally available to Customers served under AU' Standard Rate Schedules:

403.1 Single Phase Service - 120/240 Volt, 3-Wire, Grounded Neutral. Generally available where the total load is 100kVA or less for pad-mounted primary service, or 50kVA or less for pole-mounted primary service with an underground secondary in each case.

403.2 Three Phase Service – Generally available where facilities of adequate capacity are adjacent to the premises to be served. For loads where service desired by customer is not adjacent to the premises to be serviced, special contract arrangements may be required prior to service being furnished.

For customers with loads less than 75KVA, based on AU's projections, there will be charges for the cost difference between providing a single phase and three phase service. These charges will need to be paid by the customer prior to AU performing the three phase installation.

- a) 208Y/120 Volt, 4-Wire, Grounded Neutral. Generally available where the total load is 75kVA or greater for pad-mounted primary service, or 45kVA or greater for pole-mounted primary service with an underground secondary in each case.
- b) 240/120 Volt, Delta, 4-Wire, Grounded Neutral. No longer available as a new standard service.
- c) 240 Volt (and 480 Volt), Delta, 3-Wire. No longer available as a new standard service.
- d) 480Y/277 Volt, 4-Wire, Grounded Neutral. Generally available where the total load is 75kVA or greater for a pad-mounted primary service.

404 PRIMARY SERVICE VOLTAGES

Three-Phase, 13800Y/7970 Volt, 4-Wire, Grounded Neutral Service: Available only by special request where the total annual peak load at one site is projected to exceed 2500 kW(actual, metered, power factor corrected demand). AU reserves the right to deny a request for a primary voltage service.

AU will retain ownership of primary voltage equipment and conductors, unless specifically agreed upon between AU and the Customer. The point of delivery will normally be the terminals of AU' cable in the Customer's switchgear.

SECTION 500

SPECIAL SERVICES

501 TEMPORARY SERVICE

501.1 - Temporary service is intended to be supplied at secondary voltages only to customers for use during the construction of permanent facilities and before the permanent service can be installed. Temporary service for construction purposes may be obtained upon compliance with the provisions of the "Request for Electrical Inspection" (White form) and payment of the required fee (\$200) plus customer deposit for service (\$150).

501.2 - The address of the location to be supplied with temporary service must be permanently displayed on the temporary pedestal/meter location and easily readable from the street before AU will install the temporary service. All overhead and underground temporary services will be metered and billed under one of AU Standard Rate Schedules. AU will furnish only the service drop or connect the lateral and the metering equipment.

501.3 - The Customer shall provide an approved meter socket with the necessary raceway and a suitable rigid support for attachment of the metering equipment and service drop or lateral. Approved temporary meter sockets shall be installed in such a manner that the meter mounting is in an exact vertical plane. Where an underground service lateral is needed, the customer shall install secondary to an AU designated point of delivery, such as a service pedestal, junction box, or transformer. The customer is responsible for tunneling into the point of delivery and providing adequate cable for connection. All installations shall be in accordance with the (NEC®). On overhead installations, the contractor shall erect a pole, properly braced and supported to stand the pull of conductors, and of sufficient height to provide proper ground clearance and wired in accordance with the (NEC®). On all three phase temporary services, where required, the Customer shall also provide a suitable enclosure for installation of AU' instrument transformers.

501.4 Temporary Service / Construction Safety - No connections will be made to any temporary switch unless it conforms to the current AU standards and the (NEC®). All temporary services shall be equipped with ground fault equipment as required by the (NEC®) and OSHA. All temporary services shall be maintained in a safe manner. The service shall only remain as temporary for a reasonable length of

time. When directed by AU staff the temporary service shall be disconnected within 90 days or upgraded to an approved permanent service.

501.5 Deposits and Fees - All deposits for electrical services shall be in accordance with the deposit rules as set forth by the AU.

The customer will reimburse AU for its expenditures in extending service. A nominal flat fee (payable in advance) will be assessed for each single-phase temporary service of 200 amperes or less installed at the Customer's premises. The location of the temporary service will be designated by representatives of AU. The Customer will be required to pay AU for the actual cost to install and remove the single phase temporary service of 200 amperes or less, any single phase temporary service larger than 200 amperes, any three phase temporary service, any temporary service located for the convenience of the Customer, and any other special facilities requested by the Customer. The "costs of extending service" include all items of labor and materials, with the customary overhead charges necessary to furnish the customer with the service requested. It shall also include any costs involved in the dismantling of materials and their return to stock. Where materials dismantled have a salvage value, the "cost of extending service" will be credited with such salvage value.

A temporary electrical service for residential and small commercial customers shall require a minimum fee of two hundred dollars (\$200.00).

502 SERVICES FOR UNUSUAL LOAD CHARACTERISTICS

The operation of Customer equipment having a relatively high load of short or intermittent duration, (such as welders, compressor motors, elevators, and X-ray equipment,) may cause serious fluctuations of voltage and interfere with the service being provided by AU to other customers. If such a load is anticipated, the Customer must consult with AU and agree to install protective devices as required so as not to cause damage to any of AU equipment or in any way inhibit service to other customers.

In addition, special compensation may be required by AU from the Customer in those cases where it is necessary for AU to install special or larger facilities than would normally be required to provide satisfactory service.

503 EXCESS FACILITIES

AU will normally size its electrical facilities (primary cable and transformer) to serve the customer's projected load based on AU requirements. If a customer desires AU to install excess facilities, AU must be advised as soon as possible so feasibility of such service can be determined. If AU determines that excess facilities can and will be provided, the customer will be required to reimburse AU for the difference in cost between the standard and the requested excess facilities, including all labor, materials, and overhead costs. A written agreement between the customer and AU shall also be executed at AU's discretion.

504 REDUNDANT FACILITIES

AU will normally provide one set of facilities (such as a set of primary cables and a transformer) to one point of service for each Customer. If a Customer requires redundant facilities (more than one set of facilities to the same point of service), AU must be advised as soon as possible so the feasibility of such service can be determined. If AU determines that redundant facilities can and will be provided, the Customer will be required to reimburse AU for the entire cost of additional facilities, including all labor, materials, vehicle charges, and overheads. An agreement between the Customer and AU may also be executed.

505 RELOCATION OR PROTECTION OF AU FACILITIES

It is the responsibility of the Customer, when appropriate, to arrange for the relocation and/or protection of AU facilities. Any intended relocation or protection of AU facilities must be reviewed with and approved by AU in advance. The cost of any change or relocation of AU facilities for the benefit only of the Customer, and which has been initiated by the Customer, shall be borne solely by the Customer. A deposit by the Customer may also be required before the changes are made. AU will bear costs to the extent that a change or relocation benefits AU. The Customer shall not be required to pay for changes necessitated through public improvements by the City, County or State.

506 SECURITY LIGHTING

Security lighting is available under its own rate schedule classification for those Customers requesting it.

506.1 Procedure for Obtaining Security Light - A Security Light Installation Agreement must be completed in AU's office along with a \$120.00 installation fee per light fixture. (If it is only a name change from one customer to another, and there is no need for a service truck to go out, there will be no installation fee.) (See Section 1500, Exhibit 15)

Monthly charges are based on the type of light installed. Bills are due and payable upon receipt and delinquent if not paid. The rate schedule is subject to change.

AU will only set a light on a company owned pole. AU will install, own, and operate the lighting units, including pole, fixtures, and control equipment, unless otherwise agreed upon by AU and the Customer.

If installation of a pole or poles and secondary is required, AU will review this on a case-by-case basis. A minimum additional installation fee of \$500.00 per pole will be charged. AU will remove the pole and light at no charge when requested to physically disconnect the light.

507 STREET LIGHTS

AU installs and maintains streetlights in Austin based on requests from City Council and City Street Light Committee. Spacing and intensity is based on traffic volume and development density along with other factors. Requests for streetlights in public streets, subdivision street lighting and city parking lot security lighting should be made through the City Engineer's Office at 507-437-9950.

508 REWIRING EXISTING FACILITIES

The customer or electrical contractor shall contact AU when it is necessary to rewire or upgrade an existing electric service. All AU Electric Service Rules & Regulations will be followed to the degree that conditions allow, and with final approval by AU personnel. The Customer shall be responsible for maintaining the same phase rotation for 3-phase rewires.

When a customer upgrades an existing electric service with AU owned underground service laterals the ownership of the underground service lateral will transfer to the customer. Customers shall not be allowed to convert an existing underground electric service to an overhead service.

SECTION 600

600 METERS

This section covers the installation of meters and associated equipment such as current and potential transformers for both overhead and underground services. Further description of AU requirements for both overhead and underground services is covered in other sections of the Electric Rules. The requirements contained in this section are for services rated 600 volts or less. When services are required at primary voltage (such as 13800 Y/7970 volts), the metering requirements and equipment will be determined on an individual basis.

600.1 Meter Bypass – All new or rewired residential or commercial services must have an approved lever operated bypass meter socket (see Section 613 for approved bypass meter sockets). Any new or rewired service without an approved bypass socket will not be energized.

601 RESPONSIBILITIES FOR PROVIDING METERING EQUIPMENT

AU supplies and installs, at its' own expense, all meters and such accessories as required for billing purposes. This includes all revenue meters, current and potential transformers, phase-shifting transformers, test switches (required for 3Ø metering where current transformer are used), and color-coded meter wiring. The customer must purchase sockets for instrument transformer rated meters directly from AU. It shall be the responsibility of the electrical contractor or the customer to secure all other meter socket bases, or meter centers for multiple meter installations, which are approved by Austin Utilities for the intended purpose (See Section 1500, Exhibit 12 and Exhibit 18). Unless given special permission, AU will install only one set of metering equipment under each contract or application for one class of service.

602 LOCATION OF METERS

Meter locations will be agreed upon by representatives of the customer and AU, subject to final approval by AU.

602.1 Residential - All new or rewired residential services must have the meter located outdoors. Existing residential customers where the meter is located inside shall relocate the electric meter to the outside if the service panel is upgraded.

602.2 Multiple Dwellings - Where more than one meter is installed, (as on duplex apartments, apartment houses, condos, town homes or twin homes), the meters shall be grouped outdoors at a point accessible at all times to each customer and to AU employees. Complexes that have 24 meters or more may request to locate the meters inside as long as they are grouped at one location and accessible at all times to each customer and AU personnel.

602.3 Industrial and Commercial - Meters for industrial and commercial service shall be located outdoors.

602.4 Height Limits - All meters located outdoors on residential or commercial services where the meter is mounted on a permanent structure, shall have a height of not more than 6 feet and not less than 3 feet from final grade to the center of the meter. A typical residential underground metering arrangement is shown in Section 1500, Exhibit 1.

602.5 Mobile Homes - AU will individually meter each mobile home located in a mobile home court or addition to a mobile home court. Resale of metered electrical energy by the court owner will not be permitted in these facilities. Individual meter pedestals, with bypass sockets, shall be provided by the customer. Maintenance and repair of the meter pedestal is the responsibility of the customer. A typical mobile home metering arrangement is shown in Section 1500, Exhibit 2.

602.6 Meter Clearances - Meters shall be situated such that there is not less than three feet of unobstructed space in front, and one foot on all sides. Meters shall not be located where they are subject to corrosive fumes, dust, vibration, or physical damage. Meters shall not be located in carports, under porches whether open or enclosed, or along walkways or driveways where they might create a hazard to people or be subject to damage by passing objects.

602.7 Access to Meters - Meter locations shall not be hazardous or cause inconvenience to employees of AU when installing, maintaining, or reading the meters. AU personnel shall have direct and unobstructed access to AU's metering equipment at all times.

602.8 Residential Apartment Buildings - In all cases where multi-metering panels with stacked meter sockets are used, the maximum height to the center of the top meter shall be not more than 6 feet and the minimum height to the center of the bottom meter shall be not less than 2 feet indoors and 3 feet outdoors. An approved manual bypass

is required on all meter sockets. Individual apartment disconnects must be connected on the load side of the meter. If the service voltage is 120/208 volts, a fifth terminal located at the 9 o'clock or the 6 o'clock position is required in the socket and must be connected to the service neutral with a minimum size #14 AWG wire, or larger in accordance with the (NEC®) (see Section 1500, Exhibit 12). The house meter socket for apartment buildings requires an approved lever actuated positive bypass mechanism which will provide clamping pressure on the meter blades. Only one meter may be installed under one socket cover in multi-metering panels.

602.9 Commercial Multi-Metering Panels - All commercial multi-metering panels used in shopping centers, spec buildings, and multi-commercial tenant buildings shall have a maximum of four (4) meter sockets per vertical stack. In all cases, the maximum height to the center of the top meter shall be 6 feet and the minimum height to the center of the bottom meter shall be 2 feet indoors, and 3 feet outdoors. An approved manual bypass is required on all meter sockets and each individual unit disconnect shall only be connected to the load side of the meter. Each individual meter socket shall have a barrier to isolate the customer's disconnect switch and wiring from the metering area. Only one meter may be installed under one socket cover. A system neutral is required to each 5 and 7 terminal meter socket in accordance with (NEC®). The minimum wire size for this neutral shall be #14 AWG, or larger as required by the (NEC®).

Each meter shall have a separate accessible and lockable service disconnect wired in cold sequence to be used by AU.

603 GROUPED METERS

In installations requiring more than one meter, the meters shall be grouped and suitably connected such that a meter serves no more than one Customer. The height limits stated previously also pertain to grouped meters where practicable. If deemed necessary by the space available, the meters may be stacked in an orderly fashion. Any dwelling with more than one Customer living therein must be easily accessible to all tenants and to personnel of AU. There shall be an approved type of disconnecting means for each meter, which is lockable in some way to prevent reconnection by other than AU personnel. A typical multiple metering arrangement is shown in Section 1500, Exhibit 3.

604 METER IDENTIFICATION

If more than one meter is required for a building, each meter socket shall be identified and permanently designated in a suitable manner indicating the particular customer served. For outside locations the meter socket shall be marked with a stamped brass, aluminum or stainless steel tag. If the meter location is inside an engraved hard plastic tag will also be acceptable. The lettering on the tag shall be 1/2 inch block letters or numbers and the tag shall be securely attached to the exterior, non-removable portion of the meter socket and at the individual meter main disconnect. Any other means of identification is not acceptable. A permanent marking shall also be inside the meter socket base in a visible location (AU will accept a written address using a permanent marker as satisfying the requirement for marking inside the meter socket). Meters will not be installed until this requirement is met.

Each circuit shall be carefully traced and rechecked by the contractor to ensure against errors in wiring, whereby one customer might obtain service through the meter serving another customer. This is especially important when the wiring is concealed.

Electric service shall not be energized if meter sockets are not identified. It will be the contractor's/owner's responsibility to correct any errors due to misidentification of meter sockets. AU reserves the right to charge the building owner and/or electrical contractor for actual costs including any tenant account review and billing expense incurred by AU to make corrections

605 METER MOUNTING

605.1 Outdoor Meters and Meters Mounting Devices - Shall be mounted securely on permanent structures such as houses, garages, and other buildings. Mounting of meters shall be done at four corners to permit removal by AU during siding of house in future. Where outdoor meters are installed on surfaces that prevent installation of the meter-mounting device in an exact vertical plane, a meter board must be installed or the surface modified in such a manner that the meter-mounting device can be installed vertically.

The preferred meter location is within ten (10) feet of the front end of the building (house or attached garage) on single-family dwellings for new customer hook-ups. All meter locations for rewired or upgraded services shall be located outdoors with locations agreed upon between customer, contractor, and AU personnel with final approval by AU

personnel. AU has the right to refuse to energize service if these requirements have not been met.

AU does not permit installation of meters for pole top metering. Disconnect and meter sockets will not be allowed to be installed on underground transformer enclosures.

605.2 Indoor Meters Where Permitted - Shall be mounted in accordance with the preceding requirements of this section and shall be located as close as possible to the point where service enters the building. Indoor metering equipment shall be mounted securely in a vertical plane on permanent structures in a location free from moisture, high temperature, vibration, dust, or dirt.

606 METER CONNECTIONS

The Customer shall provide the necessary wiring for the meter set with the wiring arranged so that the line (supply) side can be connected to the top terminals of the socket and the load side to the bottom terminals. All conductors shall extend into the meter socket and shall be of equal length and at a minimum distance equal to the length of the socket trough. Conductors shall be crossed to allow adequate slack in the meter socket. All neutral conductors must be insulated. Where the service is three-phase, four-wire delta, and the Customer's phase wires on the load side of the meter shall be permanently identified as recommended in the (NEC®). The conductor serving power load only shall be permanently identified or have a distinctive orange covering, and shall be connected to the top, right-hand terminal of the meter socket. See Section 1500, Exhibit 23.

For underground services, the line side neutral wire is to be identified in accordance with the (NEC®). There should be sufficient slack left in the underground cables to make up for any ground shifting due to settling or extreme cold and conduit expansion sleeves. Conduits shall be provided with expansion sleeves to allow for ground movement.

607 WIRING RESTRICTIONS ON METERS AND METERING SETS

No Customer wiring is permitted to be connected to the metering, secondary wiring or under the terminals of the meter. No part of the metering set may be used as a junction box for the Customer's wiring.

608 METER TESTING

608.1 - Any Customer, who believes that a meter is failing to register the use of electricity properly, may request a meter check. Austin Utilities will test the meter using standard calibration equipment and generally accepted test procedures. Customers who request additional meter tests within a 12 (twelve)-month period may be charged for the additional tests at a standard \$200 dollar fee. AU will waive the additional test fee should the meter be found inaccurate.

608.2 - Whenever a watt-hour meter is found upon test to have an average error of more than two percent (2%) from one hundred percent (100%) or a demand meter more than one and one-half percent (1.5%) from one hundred percent (100%), a recalculation of bills for service will be made on the basis that the meter should be one hundred percent (100%) accurate with respect to a working test standard.

608.3 If the period of inaccuracy cannot be determined, it will be assumed that the metering equipment has become inaccurate at a uniform rate since it was installed or last tested and no longer than the last (6) month period, unless there is a valid reason to use another method.

608.4 - When the average error cannot be determined by test due to complete failure of all or part of the metering equipment, testing an estimate of the quantity of energy consumed based on available data will be used to determine the adjusted bills. Recalculation of the bills in the amount of the error for the past six (6) month period.

608.5 - Where the meter fails to register properly because of improper adjustment or defective parts, or is found to be registering outside the allowable limits of error, correction in the customer's billing will be made as follows:

AU will refund to, or collect from, the customer the difference between the actual billing and the corrected billing for each month that an error is known to have existed (not to exceed six (6) months).

In making adjustments for errors in meter registration, due consideration will be given to the immediate previous month's consumption, consumption in similar periods of other years, comparative uses and sizes of connected loads, and any other relevant facts.

609 METER SEALS

All connections to AU service equipment shall be made by AU personnel only. **Unauthorized connections to or tampering with any AU meter, associated equipment or meter seals, or indications or evidence thereof, subjects the Customer to immediate discontinuance of service, prosecution under the laws of Minnesota, adjustment of prior bills for services rendered, and reimbursement to AU for all extra expense incurred on the account.** In addition, when the unauthorized connections or tampering involve an inside meter, the Customer shall, at his own expense, relocate all service equipment and metering facilities outside the building. Please see Section 218.

Austin Utility meters, load control devices, current transformer cabinets and service equipment, shall have AU seals attached. Electricians/ Contractors shall contact AU staff to remove any seals. Should service equipment and metering be found without a seal, please immediately contact AU.

610 ADVANCED METER INFRASTRUCTURE (AMI)

Advanced metering Infrastructure (AMI) includes wireless communication equipment between the smart meter, located near the customer's service entrance equipment, and the utility's fiber optic data back bone with application to our electric gas and water utilities. The smart electric meter is owned and operated by the AU which measures consumption of energy, interval meter reads, power quality data, power outage data, and status of service connect /disconnect procedures. Under special circumstances, customers are given opportunity to opt-out of AU advanced meter program. The customer must submit an application and meet eligibility requirements, be a single family residential customer, property owner, responsible for paying all fees, meter located outside and readily accessible, and not a net meter application. Customers opting out are required to pay a \$235 dollar one-time service set and administration fee and an additional \$35 dollars each monthly billing cycle for meter reading related to the non-communicating digital electric meter and equipment. Should the customer discontinue the opt-out program, there is no cost to have smart electric meter installed.

611 INSTRUMENT TRANSFORMER INSTALLATION

When the ampacity of the service, single-phase or three-phase, has a total calculated load of 200 amps (320 amps for residential) or greater, it will be necessary for AU to use instrument transformers in the metering installation. These instrument transformers will be furnished by AU and installed by the Contractor on the line side of the customer service entrance disconnect switch. The instrument transformers will not be installed in pad mounted transformer compartments. The location of the instrument transformers will be determined by AU.

The Customer shall not install any additional disconnect switches or junction boxes on the line side of the instrument transformer location.

For any electrical services requiring the use of instrument transformers, the instrument transformers must be mounted in an instrument transformer compartment, or equipment designed solely for the purpose of housing metering instrument transformers. (Sometimes referred to as CT compartment or secondary metering compartment).

The Customer must furnish and install a 1-inch metering conduit from the instrument transformer location to a meter location approved by AU. The conduit shall not contain more than two 90° bends and a pull string or wire shall be installed in the conduit. Conduit runs shall not exceed 25 feet except by special permission. The conduit must be continuous and may not contain junction or outlet boxes between the service entrance and the meter equipment, except that a watertight service elbow may be used. The installation of metered conductors will not be permitted in the same raceway as unmetered service conductors. Instrument transformers installed within customer switchgear shall be installed at the factory or on-site by the electrical contractor. Meter wiring will be provided and installed by AU from the instrument transformer terminal block to the meter socket. Where the instrument transformers are installed by the manufacturer, AU will credit the customer an amount up to AU's normal cost for instrument transformers.

611.1 Underground Service from Pad Mounted Transformers -

Where service is underground from a pad-mounted transformer, instrument transformers are to be mounted in outdoor instrument transformer enclosures, secondary connection cabinets, or customer switchgear. Current transformers will not be allowed in a pad-mount transformer or enclosure. Where the service size is 1000 amps or larger, the instrument transformers are to be installed in secondary

connection cabinets or customer switchgear. (Refer to Paragraph 610.4 (a & c).

611.2 Overhead Services - Where service is provided by overhead service drops, outdoor instrument transformer cabinets will be required. Location of transformer cabinets will have final approval by AU before installation (No open air CT's or PT's will be allowed). Refer to 610.4 (a & c) for cabinet requirements.

611.3 Indoor Mounted Instrument Transformers - Instrument transformers installed indoors must have a service size of 2000 amps or greater and have prior approval from AU's metering personnel. This includes apartment building or Customer switchgear cabinets.

611.4 Instrument Transformers

611.4 (a) Secondary Metering Instrument Transformer Cabinet:

Instrument transformer cabinets shall be furnished and installed by the Customer. This includes all services either overhead or underground. All cabinets must be approved by AU meter personnel and meet all NEC requirements prior to installation. Cabinets must conform to the following:

- a. The minimum cabinet sizes
 - Voltages of 250 volts or less: 48 inches High, 25 inches Wide, and 15 inches Deep.
 - Voltages of 251- 600 volts: 48 inches High, 36 inches Wide and 15 inches Deep
- b. The door must have provisions for locking with a standard padlock.
- c. The cabinet must be hinged on the right or left side only.
- d. Cabinets shall not be used as junction boxes or service connection cabinets.
- e. Only AU metering instrument transformers may be contained therein.
- f. Cabinets must be UL approved and be the correct NEMA class for the area environment in which they are installed.
- g. A 1-inch conduit installed between the cabinet and meter socket is required.
- h. Cabinet must be designed to accept bar-type current transformers on all services 1200 amps or less.
- i. The customer is required to label the line side and load side of the conductors within the instrument transformer cabinet.

All services that require current transformers to be used will require the Customer or contractor to purchase a meter socket from the AU. (See Section 613.1 and 613.2)

611.4 (b) Primary Metering Equipment – Indoors - When indoor primary metering service is to be installed, the Customer shall furnish a compartment or switch-gear cubicle to house the primary current and potential transformers. All current and potential transformers shall be rated for metering accuracy as approved by AU. The metering point shall be located electrically between the point of interconnect and the Customer's main disconnect. A disconnecting means must be provided in all cases, so that a visible opening may be obtained between the metering equipment and the incoming primary line. The Customer must provide grounding means.

When practical, AU may request that the Customer install instrument transformers per AU specifications. In such situations, AU will credit the customer for installation and material charges up to AU's normal cost for instrument transformers.

611.4 (c) Primary Metering Equipment – Outdoors - When outdoor primary service is to be installed, AU may elect to utilize either a pole-mounted or pad-mounted primary metering equipment set. Outdoor primary metering units are furnished and installed by AU. Sharing of the material and installation costs for primary metering will be determined on a case-by-case basis.

612 SELF-CONTAINED METERING FOR COMMERCIAL INSTALLATIONS

In general, AU will install self-contained meters (meters without instrument transformers) on single phase services where the service rating is 400 amps or less and on three phase where the service rating is 200 amps or less and 250 volts or less. AU metering staff may allow the use of a 16S class 320 meter under special permission and must be 250 volts or less, and small service loads. Where such metering is to be used, the Customer shall provide a lever-operated bypassing socket (see Section 601). Such sockets permit a continuation of service upon removal of the meter for testing or maintenance. If a lever-operated bypass socket is not installed, the service will not be energized.

Commercial self-contained sockets must be rated continuous 200 amperes minimum. For information on approved meter bypass sockets, see Section 614.1. (See Section 1500, Exhibit 18)

613 MASTER METERING

613.1 - All new residential units will be individually metered. Exception: Multi-Unit facilities providing care to elderly or disabled persons may be master metered in accordance with Minnesota Rule 326B.106 Subd 12. All customers claiming an exception must provide AU, in writing, a statement that they are claiming as exception under Minnesota Rule 326.106 Subd12 and why they feel their building meets the exception requirements. AU does not determine the validity of the claimed exception and this required filing is for AU documentation only.

613.2 - All new commercial or industrial units will be individually metered. Exceptions must be approved by the AU Electric Department

613.3 - Sub metering by others for the purpose of charging individual occupants based on measured use must be in accordance with statutory requirements. Sub metering by others for information purposes or to control the use of electric power for energy is permitted. It is acceptable for sub-metering by a building's owner to measure the use of electricity by occupants in multiple-unit residential or commercial buildings, to fairly apportion the entire electric costs for the building among its occupants. (See Section 208.1(b))

614 APPROVED SOCKETS

Meter sockets installed for self-contained meters must be approved by AU prior to installation. Meter installations made with unapproved sockets will not be energized. Services energized with unapproved sockets will be subject to disconnection until the correct socket is installed.

614.1 Customer-Furnished Sockets - Meter sockets for single phase self-contained metering up to 320 amps and for three phase self-contained metering up to 200 amps are to be furnished and installed by the customer/contractor. 320 amp meter sockets are to be used on residential services only and require an approved lever actuated positive bypass mechanism, which will also provide clamping pressure on the meter blades. Three phase services over 200 amps require instrument rated sockets.

614.2 AU Furnished Sockets - Meter sockets for instrument rated meters (three phase services over 200 amps, where current transformers are used) must be purchased from AU and installed by the customer/contractor. Contact AU to obtain the proper socket and pricing. The cost of the socket will be charged to the customer/contractor.

615 SOCKET BYPASS REQUIRED

All self-contained meter sockets used for new or rewired commercial installations must have an approved lever actuated positive bypass mechanism, which will also provide clamping pressure on the meter blade. This requirement includes both single phase and three phase services, at all voltages. The socket is to be rated 200 amps minimum. The house meter for apartment buildings and exit light loops require bypasses. Exceptions are telephone booths, bus stops, billboards, and non-commercial garages.

Residential customers requiring uninterruptible service for computers, medical equipment, etc. should install an approved meter bypass socket. Residential services shall have installed an approved meter bypass socket.

615.1 Approved Bypass Sockets - Currently the Ladis and Gyr (HQ), Milbank (HD 200 Series) and Thomas & Bells/Anchor (TB Series), Square D (HD), Milbank U4701-RRL, Cutler Hammer #UTE7213BCH, Landis and Gyr #40407-025 bypasses are approved. Any other bypass socket must have approval from AU prior to installation. Meter installation made with unapproved bypasses will not be energized. Service will be subject to disconnection until the correct socket is installed.

616 SERVICE AT 480 VOLTS

Meter sockets used on 480-volt service must have a flash shield over the jaws and an approved bypass mechanism. The only approved meter sockets for 480-volt use are 200-ampere commercial types.

480 volt, 3 phase, 3 wire and 480 volt, 3-phase, 4 wire delta services will be metered using instrument transformers on both current and potentials for safety reasons. All 480 volt supplied meter sockets shall be labeled "480/277" both inside and outside! AU will supply and install all instrument transformers at no cost to the customer/contractor.

617 LOCATION OF HIGH-LEG IN METER SOCKET ON 240/120 VOLT, 3-PHASE SERVICES

The conductor with the higher voltage to ground must be connected to the terminal on the right side. The high-leg conductor must be identified as required by the (NEC®). Meter sockets with the high-leg in the wrong position will not be energized. Incorrectly wired sockets will be subject to disconnection until wiring is corrected. (See Section 606).

618 STACKED METER SOCKETS

Installation of factory assembled stacked meter sockets, such as used in multiple dwelling buildings, must be approved by AU prior to installation. House meters must have an approved bypass. Any modifications required for proper installation of meters will be the responsibility of the customer/contractor. Any extra equipment required, such as special sealing rings and fifth jaws, or additional meter installation time encountered, will be charged to the customer/contractor.

619 REMOVING AUSTIN UTILITIES SEALS AND METERS

Disconnection of AU metering equipment, load control, and cutting of seals is not allowed without obtaining prior approval.

620 CUSTOMER GENERATION

Where a customer intends to operate any type of electric generator, photovoltaic array, wind generator, or similar equipment interconnected with the AU system, special service and metering requirements must be satisfied. Contact AU for details prior to interconnecting any generation equipment.

621 PROPER GROUNDING

All metering conduits, cabinets, and sockets must be properly grounded. Service equipment and enclosures would be called on to carry heavy fault currents in the event of a ground fault. For this reason, it is imperative that meter sockets and conduits be adequately bonded to the neutral and to the ground. Bonding is to be done by threading couplings and threaded bosses in a rigid metal conduit system where the joints will be made up wrench tight. Locknuts and

bushings do not fulfill the requirement of bonding at service equipment. Grounding bushings (with bonding jumpers), bonding locknuts, threaded conduit hubs, or other means approved. Refer to NEC Article 625.250.66. If PVC conduits are used, grounding conductors must be provided and installed by the customer/contractor in accordance with the (NEC®). Electric service will not be connected to improperly grounded / bonded.

621.1 Neutral for 5 and 7 Terminal Sockets - A system neutral is required to each 5 and 7 terminal socket. The minimum conductor size is #14 AWG wire. Conductor should be sized in accordance with the (NEC®).

622 CUSTOMER DISCONNECT SWITCH

Individual customer disconnect switches should be connected on the load side of the meter. Individual customer disconnect switch and over current devices shall be connected on the load side of the meter for all service entry conductors external or outside of the building or structure. Each non-residential customer shall have a separate securable disconnect accessible to AU at all times. (If the building is multi-tenant each nonresidential customer shall have a separate securable disconnect. The disconnect shall be labeled and mounted adjacent to the meter. All pole or wood posts installations shall have a disconnecting means. No customer devices, e.g. surge suppressors, load management equipment, etc., may be installed on the line side of the meter.

623 SPECIAL SOCKETS

All special sockets, such as apartment panels, recessed, mobile home parks, socket and switch, or socket and transfer, must have AU' approval prior to installation.

624 AU OWNED EQUIPMENT

Any metering equipment furnished by AU, such as meters, load control units, instruments transformers, relays, totalizers, test switches, etc., remain the property of AU. If the equipment has to be removed or disconnected for any reason, please call AU so that the equipment can be picked up.

625 TEMPORARY REMOVAL OF METER SOCKETS FOR SIDING INSTALLATION / REPAIR

AU will temporarily remove customer owned meter sockets from premise walls for siding purposes on single and duplex meter sockets. Any meter housing containing more than two meter sockets for removal, will be at the discretion of AU personnel. Should AU's personnel not be able to perform the work, it will be up to the customer to hire an electrician/contractor to perform the task. If at any time safety is a concern, AU will have the service de-energized to perform the work. The customer/contractor shall contact AU two business days in advance to schedule the temporary removal of the meter socket for siding purposes.

626 REDISTRIBUTION OF ENERGY

All energy sold by AU is to be used by the customer for the purposes designated or implied in the rate schedule applicable to particular installation. Energy so sold may not be resold or redistributed to other metered users unless specifically approved by AU.

627 ARC FLASH

For secondary voltage services AU will provide upon request from the customer transformer size, primary voltage, secondary voltage, typical percent impedance, transformer primary fuse size and type. Please reference the maximum available secondary symmetrical three phase fault current from Exhibit 21.

628 LOAD SHEDDING AND KYZ CUSTOMER CONNECTIONS

Upon the customer's request, the customer/ contractor will install a pulse initiating device (KYZ unit) on a customer's existing meter socket. The customer should submit, in writing, all technical information concerning the customer's load monitoring equipment. AU will determine what type of pulse and amount of pulses available in a given time interval. The customer will furnish a weatherproof junction box and install a five position fused terminal, ¾ inch galvanized rigid or schedule 80 PVC conduit with ground wire from the meter socket to the weather proof junction box for connection of KYZ and load shedding from the kW meter. The customer will furnish, install and maintain all necessary equipment. Wiring will be in accordance with NEC. AU requires one amp current limiting fuses to be installed on the load side of the terminal block to provide a separation of AU and Customer facilities. AU reserves the right to interrupt the pulses at any time in order to test or change the meter Customer will be notified of any changes and change to pulse values. See Section 1500, Exhibit 13.

629 LOAD MANAGEMENT METERING

AU requires that on each residential air conditioning system and electric hot water system, a load management terminal shall be installed. The load management program is designed to reduce demand for electricity during peak usage times (“peak shaving”), to save customers money. AU is in the process of replacing the existing load management control units. Customers will be contacted by the electrician to replace the AU owned load control equipment at no charge. The cost to furnish, install, and maintain the load management equipment is the responsibility of AU and shall not be removed, disconnected or tampered with its function unless approved by AU meter department. A separate “Request for Electrical Inspection” (White form) shall be provided for each load management terminal installation.

630 CLEARANCES FROM GAS METERS

AU requires a minimum of 3 feet clearance from gas meter to electric meter socket, electric disconnect switch, or any sources or ignition. This requirement is under the natural gas code.

631 TOTALIZED METERING

Totalized metering (totalizer) is defined as the addition of multiple service or meter points so that energy and demand is registered on one Meter. This results in coincident demand for these loads, thus treating it as one larger load for billing one rate. To qualify for totalized metering, a customer must be served at a service location consisting of a contiguous property with the same occupant and each service entrance to be combined must have a minimum entrance rating of 750KVA. Totalized metering can be accomplished with hardware or software totalizers or by installing primary metering equipment. AU will, in its sole discretion, determine if totalizing is appropriate for any particular customer that qualifies for totalized metering.

SECTION 700

CUSTOMER UTILIZATION EQUIPMENT

The Customer's service entrance and utilization equipment shall be installed in accordance with all local, state, and (NEC®) requirements. It is the intent of this section to provide the Customer with recommendations concerning factors that can affect both AU and the Customer in the selection, installation, maintenance, and operation of the Customer's utilization equipment. If concerns arise that are not covered in this section, AU should be contacted.

701 PROTECTION OF CUSTOMER EQUIPMENT

The customer is advised to provide adequate protection against the effects of outages or voltage spikes in accordance with the NEC or other pertinent sources of information for all types of motors and other equipment.

Equipment that should be protected includes, but is not limited to:

- Motors
- Computers
- Electronic equipment
- Equipment in which computers or electronics form an integral operating part.

Equipment should be protected under all conditions, including:

- Overload
- Loss of voltage
- High or low voltage
- Loss of phase(s) (e.g. single phasing on polyphase motors)
- Re-establishment of service after any of the foregoing
- Phase reversal
- Motors that cannot be subjected to full voltage on starting
- Harmonics or wave form irregularities

Failure to provide such protection may result in needless damage to equipment and the expense of delay and repair.

Sensitive electronics, such as microprocessor-based home electronics and business computers, are susceptible to damage due to voltage spikes or surges. Before any microprocessor-based electronics are installed:

- Wiring practices meet manufacturer specifications. (For example, proper grounding and dedicated circuits are important.)
- Consideration should be given to installing transient voltage surge suppression.
 - At the main service entrance, and
 - At the point of use
- An uninterrupted power supply (battery backup) should be considered in a momentary voltage dip or outage would cause loss of data.

702 MOTOR STARTING CURRENTS

Generally, all motors require a starting current substantially greater than their normal running current. Where starting currents are excessive, an abnormal drop in supply voltage will result. In order to minimize the unfavorable effects of such voltage drops, it is essential that the Customer's motors do not exceed the allowable starting characteristics as shown in Table 430-151 of the (NEC®).

Customers planning to install any motor larger than 5 hp single phase or 25 hp three phase, must contact AU for special permission. AU may require reduce voltage starters. Motor installations that cause power quality problems for other customers shall be corrected at the owner's expense.

703 Blank

704 TANKLESS WATER HEATERS

Tankless water heaters, also known as on-demand water heaters, use a large amount of energy to heat water. Tankless water heaters shall not be installed without confirming that the electric service is of sufficient capacity to supply the power to heat water safely. These water heaters should only be installed after contacting AU Electric Department to confirm the service and electric needs. Installations that cause power quality and voltage problems for other customers shall be corrected at the owner's expense.

705 ELECTRIC VEHICLE CHARGING STATIONS

Electric vehicle charging stations should only be installed after contacting AU's Electric Department to confirm service can meet the electric needs of the equipment.

706 POWER FACTOR

In order to improve the efficiency of AU' distribution system, the Customer's utilization equipment shall maintain an average power factor as close to unity as possible.

Some of AU's rate schedules include a demand charge and a penalty for an average power factor that is less than 95%. Details of the method of billing for such Customers can be obtained from the AU Representative. For new services, it is suggested that the Customer's utilization equipment be designed for operation at high power factor or with capacitors that are switched on and off with the equipment. See Section 1500, Exhibit 14 for correcting customer's power factor.

All motors operating at 220 volts or more, larger than 3 HP shall have capacitors to correct for power factor. These capacitors shall be energized when the motor is operating.

AU will calculate the power factor of Customers in designed rate classes by installing metering to measure KVAR hour values. See Section 601 for Customer's responsibilities in providing metering equipment.

707 FAULT CURRENTS

The Customer's service equipment and other devices shall be adequate to withstand and interrupt the maximum available fault current. For single-family residences with service equipment rated 200 amperes maximum and 120/240 volts, single phase, equipment shall have a minimum interrupting rate of 10,000 amperes symmetrical and other equipment shall be braced to withstand that minimum value. For other than single-family residences, the AU Representative shall be contacted to determine maximum existing and future anticipated fault currents.

708 ARC FLASH

For secondary voltage services AU will provide upon request from the customer transformer size, primary voltage, secondary voltage, typical percent impedance, transformer primary fuse size and type. The maximum available secondary symmetrical three phase fault current from Please refer to Section 1500, Exhibit 22, Maximum Fault Currents. It is highly recommended when customers are performing maintenance work on or near exposed equipment or circuit parts that their electrical system be de-energized whenever possible.

709 WIRING ADEQUACY

The (NEC®) specifies the adequacy of wiring with respect to safety, but such installations may not be efficient, convenient, or adequate for good service of future expansion of electrical use. In many instances, the installation of wiring capacity greater than minimum code requirements is strongly recommended.

710 CUSTOMER-OWNED GENERATING EQUIPMENT

Unless authorized by written agreement, electric generating equipment installed by the Customer shall not be interconnected or operated in parallel with AU' system. The Customer shall own, install, operate, and maintain electrical interlocking equipment, which will prevent parallel operation, and such equipment shall be approved by AU prior to installation. To prevent a hazard to personnel and damage to Utility equipment, whenever approval has been given for standby generation, the customer shall install an approved double throw switch. This switch shall completely disconnect the Utility service from the customer's system whenever the generator is used. **(Compliance with this rule will be rigidly enforced.)**

Any cogeneration facilities will conform to the written AU Cogeneration Policy. Please contact AU for specific requirements relating to generation installation designed to operate in parallel with AU distribution system (e.g. solar, wind). AU will review the customers design for interconnection acceptance only. AU will not approve the reliability or adequacy of the customers design. AU will not assume any responsibility for the protection of the customer's facility or any portion of the customer's electrical equipment. The customer is responsible for the protection of their equipment from damage caused by faults of disturbances on AU's system.

Customer-owned generating equipment shall be installed without causing adverse effects to AU system or equipment and without introducing potentially dangerous situations to AU's personnel or public.

Certain types of generating equipment may qualify for net metering. Please contact the AU Electric Department for details. Net meters are bidirectional meter that measure both directions of power flow and are used on distributed generation that utilizes renewable energy sources. This allows the customer to generate in parallel with AU and sell back excessive generation. Production meters are required and measure the gross generation of a distribution connected generator. A single point of manual AC disconnect shall be installed between the generation source and the production meter, adjacent to the production meter. The customer supplied production meter socket or CT compartment shall meet all requirement of Section 600. The production meter shall be located within 10 feet of the existing billing meter.

Labels identifying generation source and safety requirements shall be weather proof, durable and permanently (screws or rivets) attached to the meter socket or other equipment as necessary.

711 ENERGY CONSERVATION

AU encourages the prudent and efficient use of the electric power and energy. Customers desiring special information or other assistance regarding the efficient end use of electricity should contact the Energy Services Manager at 507-433-8886.

712 CUSTOMER'S OBLIGATIONS

712.1 Increased Load – In the event the Customer desires to increase load, such as additional electric heat, increased motor loads, etc., they shall give AU sufficient advance notice, so that AU may provide added facilities if necessary. If the Customer fails to notify AU and AU equipment is damaged as a result of such increase in load, the Customer shall reimburse and make payment to AU for such damages.

712.2 Balancing of Load – AU will not serve single-phase loads in excess of 75 kVA on a 13,800 volt system, except by special arrangement. Customer wiring on three-wire single-phase installations must be arranged so that the connected load from one phase to neutral does not exceed 60% of the total connected load. AU will not install three-phase where single-phase is adequate. Motors up to and including 5 hp can be served on single-phase. Customers requesting

three-phase service for motors 5 hp and below will be charged for this service.

Except in the case of three-phase four-wire delta services, the current unbalance in three-phase services shall not exceed 10 percent of the current that would be required at maximum load under balanced conditions.

712.3 Total Harmonic Distortion (THD)

712.3 (a) - The application of any nonlinear load by the Customer (e.g., static power converters, arc furnaces, adjustable speed drive systems, etc.) shall not cause voltage and/or current Total Harmonic Distortion (THD) levels greater than industry accepted levels on AU' electric system at the point of power delivery to the Customer's facility. Please refer to IEEE Standard 519-1992, "IEEE Recommended Practices and Requirements for Harmonic Control in Electric Power Systems."

712.3 (b) - The Customer shall disclose to AU all nonlinear loads prior to connection. AU may test the Customer's load to determine the THD levels.

712.3 (c) - It shall be the responsibility of the Customer to assure that the THD requirements are met, including the purchase of necessary filtering equipment. Any load found not in compliance with this policy shall be corrected immediately by the Customer at the Customer's expense. If not corrected, AU may disconnect service to the Customer's facility.

712.3 (d) - The Customer shall be liable for all damages, losses, claims, costs, expenses and liabilities of any kind or nature arising out of, caused by, or in any way connected with the application by the Customer of any nonlinear load operating with maximum THD levels in excess of the values stated in 708.3(a). The Customer shall hold harmless and indemnify AU from and against any claims, losses, costs of investigation, expenses, reasonable attorney's fees, damages and liabilities of any kind or nature arising out of, caused by, or in any way connected with the application by the Customer of any nonlinear load operating with maximum THD levels in excess of the values stated in 708.3(a).

712.3 (e) Voltage Flicker – AU uses IEEE Standard 141--1976 as a guideline for the level of allowable flicker caused by a customer load that may affect other customers. Customers are not allowed

to start any load on AU' system that produces unacceptable levels of flicker which affect customers. Customers are responsible for correcting unacceptable flicker problems in a timely manner when notified by AU.

713 CARRIER CURRENT - CUSTOMER RESPONSIBILITIES AND LIMITATIONS

AU reserves the right to use carrier frequency signals on its system for communication, system operation and equipment control, and shall not be held liable for any resulting damages. In general, signals of this nature will not interfere with customer processes. Customers should install protective equipment if such frequencies might damage or interfere with their apparatus. Contact your AU representative if you have specific concerns.

Customer-owned carrier current transmission, broadcasting or control, are not allowed on the AU system.

714 THAWING WATER SERVICES

Because of the danger of damage to equipment and damage to the electric service, AU does not permit direct line connection to water pipes for thawing purposes. Customers or contractors desiring service for water pipe thawing should consult AU.

SECTION 800

OVERHEAD SECONDARY SERVICES

AU will supply overhead secondary service (600 volts or less) at the voltages and under the conditions specified in other sections of this publication. The service entrance location will be specified by AU. This section includes information on distribution transformer size, overhead service drop, and connections to the Customer's premises or equipment. Metering and customer equipment requirements are covered in other sections of this publication. The requirements of this section apply to all residential, commercial, and industrial customers.

801 MAXIMUM TRANSFORMER SIZE

801.1 – The maximum overhead transformer size installed by AU will be either one 50kVA transformer for a single-phase application or three 15kVA transformers for multiphase applications. If a larger transformer size is required for a particular application, it shall be a pad-mounted type.

801.2 – One or more secondary services may be supplied from a transformer; the number of services from a transformer shall be determined by AU depending upon the application.

802 SERVICE DROP CONDUCTORS

802.1 – An overhead drop shall be furnished by AU to a suitable support on the customer's premises. This support shall be located so that the service wire will not cross over the building. The service drop for new services will be twisted wire triplex (3 wires) or quadruplex (4 wire) configuration from distribution system to the point of attachment on the customer's premises.

802.2 – Customer's portion of the service shall consist of conduit, a weather-head, and wire, furnished by the customer and attached to their building. Tails shall be left on the customer service wires extending a minimum of three (3) feet beyond the weather-head. The neutral wire shall be identified and shall be continuous (no cut) from the weather-head to the entrance switch (unless otherwise approved by AU).

802.3 – Existing services may either be a twisted wire or open wire configuration. If necessary for various reasons, AU may change a service from an open wire to a twisted wire configuration.

803 OVERHEAD CLEARANCES

803.1 – The service drop must be so located that the minimum clearance as specified in the latest editions of the (NEC®) and the (NESC®) (ANSI C2) are maintained. An illustration of the clearances required is shown in Section 1500, Exhibit 4. It is strongly recommended that the customer contact the AU Electric Department if the service passes over a roof, balcony/deck, or within 5 feet of a window/door for additional clearance information. AU will not energize an electric service with an observed violation.

803.2 – Service drop conductors shall not be installed above a hot tub/swimming pool or surrounding area extending 10 feet horizontally from the pool edge, diving structure, observation stands, towers or platforms.

803.3 – Overhead Service Construction

The point of attachment to the customer's premises shall not be less than ten (10) feet above the final grade at a height to permit a minimum clearance for the lowest wire as tabulated below:

- Twelve (12) feet above private sidewalks
- Eighteen (18) feet above roads, alleys, streets, and public sidewalks
- Eighteen (18) feet above farm driveways
- Twelve (12) feet above drives to residential garages
- Twenty-two (22) feet above State Highways.
- Eighteen (18) feet above driveways used by trucks.

804 POINT OF ATTACHMENT

804.1 – A solid point of attachment for supporting the service drop on the building shall be provided by the Customer at a point, which will comply with previously stated clearances. Where the required heights and clearances cannot be maintained by a point of attachment on the building, the Customer shall provide a service mast which is of a permanent nature and of sufficient strength to support the service drop at the required minimum clearance. Typical building attachment and

service mast installations are shown in Exhibits 5 and 6, respectively. In such an installation, 2-inch or larger galvanized iron conduit or 3-inch or larger rigid aluminum conduit shall be used. AU reserves the right to decline to connect its service drop to an extension support, which, in its judgment, constitutes a hazard to life or property.

804.2 – If it is necessary that this service extend greater than 30” above the roof, the pipe size shall be increased accordingly, to give suitable strength to support AU service connection. If the conduit is not increased in size, a tie to the building must be supplied by the customer to support the service wires.

805 SERVICE ENTRANCE

805.1 – The Customer’s service entrance wiring shall terminate at a point so located that the service drop from the supply lines will not interfere with windows, doors, awnings, drainpipes, or other parts of the building or other obstructions so that only one bracket is required.

805.2 – Customer’s portion of the service shall consist of conduit, a weather head, and wire, furnished by the customer and attached to their building. Tails shall be left on the customer service wires extending a minimum of three (3) feet beyond the weather head. The neutral wire shall be identified and shall be continuous (no cut) from the weather head to the entrance switch (unless otherwise approved by AU).

SECTION 900

UNDERGROUND SERVICES

901 RESIDENTIAL SERVICES

Residential services shall be located underground and shall extend from the source designated by AU to and through the meter socket.

Residential services, service entrance, service panel or future equipment to be relocated, upgraded, or replaced for any reason shall be placed underground. AU will designate a point of delivery for connection of the Customer's secondary underground service lateral. The point of delivery will be a service pedestal, junction box or secondary terminals of a pad mount transformer. In either case, the Customer shall install, own, operate, and maintain the facilities specified in Section 902. In addition, the Customer will be charged an amount, which reflects any additional cost incurred by AU in providing service to the point of delivery. All such charges must be paid by the Customer before AU will commence installation of the necessary facilities.

902 UNDERGROUND IN RESIDENTIAL DEVELOPMENTS

902.1 (a) - AU requires the complete underground installation of primary and secondary distribution service laterals to new structures in all residential zones, except in those cases where it is determined by AU that such underground installations are either technically or economically undesirable.

902.1 (b) - AU will designate a point of delivery for the connection of the Customer's secondary underground service lateral. The point of delivery will be a service pedestal or junction box; the terminals of a pad mounted transformer, or a meter enclosure. In general, AU will install, own, operate, paint Munsell green, and maintain all facilities on the source side of the point of delivery, including the junction enclosure and connections; and the Customer will install, own, operate, and maintain all secondary cables, conduit, and related service equipment specified in other sections of this publication on the load side of the point of delivery.

902.1 (c) - Points of delivery will be located within AU' easement area along or near a front or rear property line, unless it is necessary or desirable to designate locations which are closer to the metering point(s). In such cases, the customer will be charged for the installed cost of any additional lengths of underground

distribution cable and conduit from the property line to the point of delivery. Such charges shall be in addition to any other charges specified herein. Customer's secondary service lateral shall be located entirely within the boundaries of the property served and adjoining public right-of-way to the source of power designated by AU.

902.1 (d) - AU primary and/or secondary distribution laterals will normally be installed within front lot line utility easements provided by the Customer as a part of the recorded property plat. All utility easements requested by AU are to be granted by the Customer at no cost to AU.

902.1 (e) - Before this type of underground service can be made available, the sub divider must provide a ten- (10) foot combined utility easement on the property. Final grades must be established before the system is installed and ground brought to final grade level. Large filled areas must be compacted to prevent settling. Lot boundaries shall be marked by the sub divider or owner prior to installation. The charge to the sub divider for this type of installation will be the estimated construction costs to include all components necessary to serve the individual lots.

902.1 (f) - The developer of a new subdivision is responsible, during general development, for installing road crossing conduits per AU' specifications (refer to Section 1500, Exhibit 10). The contractor is responsible for all costs associated with road crossing installations.

902.2 - Additional information regarding AU and Customer responsibilities for underground installation is provided in Section 1500, Exhibit 9 - Responsibilities of Residential Services.

902.3 - Residential Undergrounding in Overhead Areas
AU's program to upgrade residential rear lot easement areas includes placing electric facilities underground. Customers residing in these residential zones served by overhead lines are encouraged to replace there secondary service underground. The customer shall install, own operate, and maintain the secondary underground service as specified in section 901. AU will provide a secondary pedestal as the point of delivery at a specific location to accommodate the customer's secondary underground service upgrade.

903

UNDERGROUND SERVICE CONSTRUCTION

903.1 Dwelling Service Conductors – The minimum service conductor size for 120/240 volt, 3-wire, single-phase, dwelling service, service entrance, service lateral or service feeders shall be 1/0 AWG.

For service conductors greater than 100 feet from AU' point of delivery to the service entrance disconnect, a minimum size of 4/0 AWG shall be used. The service conductor length shall not exceed 300 feet.

A slack loop to provide for ground movement shall be provided on all service conductors at each riser location, meter location, and joint location. An electrical expansion sleeve will be provided at the dwelling on the line side of the riser conduit to prevent undo stress and movement of the meter socket.

Service Conductors passing below existing or proposed paved areas or above grade structures such as decks, shall be installed in minimum 2 inch PVC Conduit, Schedule 40 PVC duct of the appropriate size. Tracer wire to locate duct shall be provided on all duct installations. Contractor shall install marker tape in all trenches.

903.2 - Underground electric service shall be installed a minimum of twenty-four (24) inches and a maximum of 30 inches below the final grade. Conductor shall be installed in as straight line as possible from power source to meter or service entrance. Conductor trench shall be back-filled and compacted with a good fill material, free of rocks and foreign material to prevent damage to the cable. Contractor shall install marker tape in all trenches. Electrical contractors or customers must call for inspection with open trench. Wiring installations must be inspected and approved by an authorized State Electrical Inspector.

903.3 - When a residential service extension is greater than 300 feet, the primary duct extension is to be furnished and installed by the contractor. Duct shall be 2" PVC Schedule 40 to the point on interconnection with AU, including steel elbow and 10 feet of steel riser conduit securely attached to the pole.

Secondary laterals and secondary feeder duct extensions are to be furnished and installed at the point of interconnection with AU, including the riser shall be sleeved in two-inch PVC conduit (Schedule 80) from fifteen (15) inches below grade to a minimum of eight (8) feet

above ground. Conduit sleeve shall be securely attached to the pole. A thirty (30) foot tail of service conductor should be left at the pole.

904 UNDERGROUND SERVICE TO COMMERCIAL AND INDUSTRIAL CUSTOMERS

904.1 – AU requires the underground installation of primary and secondary distribution service laterals to new commercial and industrial structures.

904.2 – AU will designate a point of delivery for the connection of the Customer's secondary underground service lateral. The point of delivery will normally be the secondary terminals of a pad mounted transformer placed at a mutually agreeable location on the Customer's property, as close as practicable to the metering point.

904.3– AU will install, own, operate, and maintain the primary underground cable, the distribution transformer, and the transformer secondary connections.

904.4 – The primary cable will be installed in Schedule 40 PVC conduit, sized to AU' construction standards from AU' main distribution system, on or adjacent to the Customer's property, to the distribution transformer. If underground main distribution facilities are located on the Customer's property; the Customer shall provide and install the conduit from a designated tap point to the distribution transformer.

If overhead main distribution facilities are located on the Customer's property, the Customer shall provide and install the conduit including the large sweep steel elbow and ten feet of steel conduit securely attached to the pole from the riser pole to the pad mounted distribution transformer. See Section 1500, Exhibit 8 for details.

904.5 – The Customer shall install, own, and maintain a concrete transformer pad to AU' specifications. If the transformer is located in an area where it may be subject to physical damage (e.g. from vehicular traffic), AU may require the Customer to furnish and install an approved means of protection. Contractor shall install, own, and maintain the transformer ground grid to AU' specifications. See Section 1500, Exhibit 19 and Exhibit 20.

904.6 – The Customer shall install, own, and maintain all secondary cables, connectors, conduits, and cabinets from the transformer to the building service entrance; the cables and conduit shall be buried 24 inches minimum below final grade. If service is such that a secondary

lateral is to be installed directly from AU' main secondary distribution system, the secondary cables and conduit shall be installed, owned, and maintained by the Customer. If service is such that a secondary lateral is to be installed from AU' overhead distribution system, the conduit, pole Schedule 80 PVC riser system, pole weather head, and cables shall be installed, owned, and maintained by the customer.

AU must approve the design of all secondary bus duct and cable bus designs. The installation will be inspected by AU and the secondary connections to the transformer will be made by AU. It is the Customer's responsibility to coordinate with and provide secondary terminals and the necessary information to AU to assure that adequate connections are made at the secondary terminals of the transformer.

904.7 – AU will furnish and install the meter set in accordance with the requirements of Section 600.

904.8 – Underground service to commercial centers and industrial parks will be arranged for on an individual basis. In those cases where it is necessary to extend AU' main distribution system into such centers or parks, the Customer will be charged for the extension in accordance with Section 700 Extension of Service.

904.9 – The maximum number of secondary connections available shall be:

Single Phase:
Six (6) 350 MCM conductors copper per phase

Three Phase:

<u>Transformer Size</u>	<u>No. of Conductors Copper Per Phase</u>
45 kVA	3
75 kVA to 500 kVA	4
750kVA to 1500kVA	6
2000kVA to 2500kVA	8

The maximum size secondary conductor to be installed in a 3-phase transformer is 500 MCM copper. Parallel conductors shall be of identical wire size.

Any service requiring more conductors per phase than listed above must utilize a customer-provided secondary connection cabinet.

904.10 – Secondary cables installed in an AU manhole must be copper conductors.

904.11 – Secondary cables installed to a three-phase pad mounted transformer shall be copper.

904.12 – The customer shall be responsible for the service entrance to the source of power as determined by AU. This includes the removal and replacement of sidewalks and/or pavement as necessary to provide complete service entrance continuity.

904.13 – Where a pad mount transformer is the source, service conductors shall be terminated by AU. The customer shall supply lug connectors having a minimum of two bolts at NEMA spacing's in their tongue.

904.14 – Current transformers (CT's) and Potential transformers (PT's) for metering are provided by AU. The customer must provide a CT cabinet for all services larger than 200 amps.

905 SECONDARY CONNECTION CABINETS

Where secondary connection cabinets are necessary, the following apply:

905.1 - Cabinet assemblies will be suited to the installation and meet: AU and (NEC®) requirements.

905.2 - Cabinets shall be constructed with provisions for bar-type or donut-type current transformers.

905.3 - Conduits from service equipment to connection cabinet and from transformer to connection cabinet will be furnished and installed by electrical contractor as concrete pads are being formed and poured. Conduit systems shall meet AU requirements. Above-grade raceway from the transformer to the connection cabinet is not allowed. See Section 1500, Exhibit 18

906 TRANSFORMER CLEARANCES

906.1 Placement - Where pad mounted transformers and equipment in pad mounted enclosures are installed, the minimum clearances specified in Exhibit 7 must be maintained. Vehicle access shall be maintained to allow for transformer replacement and maintenance. Fences, shrubbery, manholes, junction boxes, and trees may be

installed by the customer if the specified clearances are maintained, grade is not altered, and the underground cable is not endangered.

906.2 Painting of Transformers - The customer, at his own expense, may paint the service transformer, CT cabinet, and meter socket. AU will approve the painting on a case-by-case basis. The customer is responsible for all cost to repaint or maintain the paint. The customer shall not cover labels, warning signs, meter-viewing windows, or effect the operation of the equipment. AU is not responsible for any repainting should the transformer or equipment need to be replaced.

907 WINTER INSTALLATION

Underground cable installation at the Customer's request between November 15 and April 30 will be subject to AU' approval and a winter installation charge. AU cannot guarantee installation and connection of service during the winter season. The customer shall be required to pay a per foot additional fee for underground duct and cable installation, at customers request, after frost has been established in the ground to an average depth of 6 inches or more. The amount of the frost charge depends on the depth of frost. AU requires that the estimated frost charges be paid in advance of performing the work.

907.1 Installations scheduled on or after November 15 will be attempted at the discretion of AU, based on ground conditions.

907.2 Where conditions do not permit the completion of a scheduled installation, or where a development cannot be completely brought to grade in time, partial installation will be made at no added cost under the following conditions:

- a. Partial** installation must conform to final design layout, including placement of one (minimum) permanent transformer.
- b.** Partial installations must be contiguous with existing facilities.
- c.** Total project fees must be paid before partial installation will be approved.
- d.** All standard pre-and post-installation site conditions must be met for partial installation.

907.3 Temporary service to a permanent structure in an undeveloped area will be provided on at "at cost" basis.

908 INSTALLATION IN ROCKY SOILS OR POOR BACKFILL

The Customer shall be required to pay an additional fee if rock or poor quality backfill is encountered during installation of AU facilities. The fee will be based on the cubic feet of unsuitable material encountered

by AU or our contractor during installation. AU may require that the Customer pays an estimated fee prior to performing the work.

909 TOTAL UNDERGROUNDING

AU does not install underground vaults, manholes, or submersible transformers on Customer property. If the presence of permanent structures up to the property lines, or other conditions, precludes the installation of pad mounted equipment on the Customer's property, primary service will normally be provided.

910 SERVICE GROUNDING

A second supplemental service ground electrode as a second eight-foot ground rod shall be bonded to grounding electrode conductor. The second ground rod shall be placed a minimum of eight feet from the first ground rod electrode and shall be a minimum of four feet beyond structure including overhang. This is additional ground electrode to NEC. All installations shall be in accordance with NEC.

Gas pipe shall not be used as a grounding electrode.

In the rural areas, a suitable ground shall be provided at the entrance switch as provided for in the (NEC®).

911 SERVICE RELOCATION

When AU pole or service pedestal must be replaced or relocated because of a request from the customer, the customer is responsible for moving or replacing the underground service at his own expense.

If AU replaces or relocates the pole or service pedestal of its own volition, AU is responsible for the expense of moving or replacing the underground service.

AU shall perform, at its own expense, the labor necessary to attach, maintain, or relocate that portion of the underground service, which is above ground and attached to AU pole or located in vaults, manholes, service pedestals, or junction boxes owned by AU.

912 REPAIR OF UNDERGROUND SERVICES

AU customers own their secondary underground electric service conductors. Underground residential electric services are the Customer's responsibility to repair. All commercial and industrial services are the Customer's responsibility to repair.

AU reserves the right to condemn the secondary electric service and require replacement if such cable is damaged, overloaded, hazardous, or for any condition deemed necessary by AU.

The customer and their agents shall not perform work in or on service pedestals, transformers, switching cabinets, vaults, manholes, junction boxes, poles, or towers owned by AU.

SECTION 1000

SERVICE EXTENSION

AU will extend its services within its authorized service boundaries, in accordance with the requirements for overhead and underground extensions, only when the anticipated revenue from the sale of the additional service, which will result from the extension, is sufficient to justify the expenditure. When the expenditure is not so justified, the extension will be made only if the Customer pays to AU the portion of the capital expenditure not justified by the anticipated annual revenue.

1001 OBJECTIVES

To provide a method by which AU Electric Department will extend electric lines and facilities to serve Applicants that have made a written application for electric service within the retail service area of AU.

1002 POLICY CONTENT

- A. In the event that upgrading, construction, or extension of facilities is required to provide service to the Applicant, AU will furnish the facilities required but not to exceed a cost greater than the allowable construction credit established for the service classification being applied for, unless the Applicant makes an in-aid-to-construction contribution.
- B. The estimated construction investment shall include the costs of materials, equipment, engineering and labor, including administration overheads, fringe benefits, and the costs of service transformers and metering equipment, needed to complete the construction for service to the Applicant. The estimated construction investment will include only the non-betterment costs of the construction required to provide service to the Applicant. A non-betterment cost excludes the costs of replacement or addition of facilities solely for the benefit and at the election of AU.
- C. Where the estimated construction investment exceeds the established allowable construction credit, AU will receive from the Applicant an "In-Aid-To-Construction" contribution. The in-aid-to-construction contribution will be determined as the monetary difference of the non-betterment portion of the

estimated construction investment less the allowable construction credit established by this policy.

- D. The allowable construction credits established by this policy are as follows:
1. The service furnished to a customer of AU is subject to the maximum contributions to serve the load as listed in Appendix One; Table One. Costs in excess of the amounts are subject to an in aid-to-construction contribution.
 2. Commercial Customers who make connections under this policy are required to sign a Five year contract with AU for service under the proposed rate. Customers are not allowed to change rate class during the five year period without prior approval of AU. AU may assess a charge equal to the difference between the amount of time serviced under the rate and the remaining time on the five year contract.
 3. Customers with an existing service who are requesting an upgrade of the facilities to serve additional load, AU will contribute the amounts included in Appendix One; Table Two based on the additional (new) load.
 4. AU will connect facilities up to the service point of the customer. Costs beyond the service point are the responsibility of the customer and not subjected to contribution from AU.

1003 Table One – Construction Allowance for a New Customer

Customer Class	Contribution Amount	Calculation Basis
General Service (<25kw) (210)	\$ 0.0806	Annual kWh Projected
General Service Demand (310,315)	18.23	Annual kW Projected
Bulk Power (>10,000kw) (510)	14.29	Annual kW Projected
Residential Subdivision (5 year)	401	Subdivision Lot

1004 Table Two – Construction Allowance for Existing Customer Requesting an Upgrade of Service

Customer Class	Contribution Amount	Calculation Basis
General Service (<25kw) (210)	\$ 0.0806	Annual kWh Projected
General Service Demand (310,315)	18.23	Annual kW Projected
Bulk Power (>10,000kw) (510)	14.29	Annual kW Projected

SECTION 1100

This section intentionally left blank

SECTION 1200

UNDERGROUND LOCATIONS

1201 ONE-CALL

Minnesota Statute, Chapter 216D requires an excavator to contact the utility notification center (Gopher State One Call) at least 48 hours before beginning an excavation. The excavation notice may be made by call the center at 1-800-252-1166 and providing the following information:

1. Name of the individual calling.
2. Precise location of the proposed excavation.
3. Name, address and telephone number of the excavator.
4. Excavator's field telephone number.
5. Type and extent of proposed excavation.
6. Any anticipated use of explosives.
7. Date and time when excavation is to commence.

1202 EXCAVATION

"Excavation" means an activity that moves, removes, or otherwise disturbs the soil by use of a motor, engine, hydraulic or pneumatically powered tool, or machine-powered equipment of any kinds, or by explosives. Excavation does not include:

1. The extraction of minerals.
2. The opening of a grave in a cemetery.
3. Normal maintenance of roads and streets if the maintenance does not change the original grade and does not involve the road ditch
4. Plowing, cultivating, harvesting, and similar operations in connection with growing crops, trees, and shrubs, unless any of these activities disturbs the soil to a depth of 18 inches or more.
5. Gardening, unless it disturbs the soil to a depth of 12 inches or more.
6. Planting of windbreaks, shelterbelts, and tree plantations, unless any of these activities disturbs the soil to a depth of 18 inches or more.

1203 REQUESTS

AU encourages that underground facilities locations be requested prior to all construction or activity that disturbs the soil, including especially those activities that involve hand tools.

1204 CONTACT WITH ELECTRIC CABLE

Any contact with an electric cable during excavation must be reported immediately, day or night, by calling AU direct at 507/433-8886.

1205 DAMAGES

The Contractor shall be responsible for any damages to the property of the Utilities resulting from not following the guidelines of Gopher State One-Call. A violation of these regulations shall constitute a misdemeanor.

SECTION 1300

ELECTRIC WELDERS

- 1300** Electric welders shall not be connected to the residential distribution service. Any customer who desires service for an electric welder is required to submit application for availability of such service to the office of the AU. In all instances, any welder that interferes with other normal customer electrical service shall be discontinued. The customer shall reimburse AU for its expenditures in providing this service. Please refer to Section 500 Special Services.

SECTION 1400

POLE ATTACHMENT

1400 Attachment of any kind to power or street light poles are not generally permitted. In certain cases attachment to power or street light poles by other utility entities are granted through a Pole Attachment Agreement and or written permission. Application for pole attachment Agreement should be made to Electric Department.

1400.1 Small Cell Fee and Requirements: Utility entities requesting attachment of any kind to AU power or street light poles for small cell radio systems shall include a City Agreement, Easement Right Away Agreement with City and an AU Agreement for Pole Attachment(s) to utility facilities.

The following AU terms and conditions apply;

- AU Administrative fee - \$5,000.00 per vendor.
- AU Engineering Approval fee - \$1,000.00 per attachment point.
- A Pole attachment annual fee - \$1,200.00 per pole.
- Fixed and Energy Electric Costs - Non metered rate tariff applies for services under 40 amps and metered service tariff applies for services over 40 amps. AU will verify usage and adjust annually.
- Electric connection to AU system (service connect fee) - \$50.00.
- Installation “make ready” work fees will be case by case basis.
- Submittals by Vendor entity will need to submit engineered installation specifications.

The vendor entity is required to establish electric service disconnect for each pole attachment location. The vendor entity or agent shall not enter nor mount equipment in the power area of the utility pole except the antenna placement. All work and installation methods shall meet AU service rules and regulations, and meet both NESC and NEC codes. Approved by State of MN electric inspections required for all vendor entity equipment installation.

AU application for service/service agreement and deposit required.

SECTION 1500

EXHIBITS

EXHIBIT

- 1 Typical Underground Residential Metering Arrangement
- 2 Typical Mobile Home Metering Arrangement
- 3 Typical Multiple Metering Arrangement
- 4 Secondary Service Drop Clearances
- 5 Typical Residential Overhead Service Installation
- 6 Typical Residential Service Mast
- 7 Location of Pad Mounted Transformers Near Buildings
- 8 AU & Customer Responsibilities
Associated w/ Three Phase Installations
- 9 AU & Customer Responsibilities
Associated w/ Residential Distribution (URD) Installations
- 10 Duct Installation Road Crossing
- 11 Street Crossings
- 12 Agreement for Electric Distribution Line Extension
- 13 Types of Meter Sockets
- 14 Load Shedding Customer Connection
- 15 Multipliers to Determine Required Capacitor KVARs
For Correcting Power Factor
- 16 Security Light Agreement
- 17 AU Utility Theft/Diversion Procedure
- 18 Three-Phase Transformer Concrete Pads
- 19 Grounding Grid for Pad Mounted Equipment Installation

SECTION 1500

EXHIBITS (cont'd)

EXHIBIT

- 20 AU Secondary Metering Compartment Grounding
- 21 Maximum Fault Currents
- 22 Meter Socket Wiring

EXHIBIT 1

TYPICAL UNDERGROUND RESIDENTIAL METERING ARRANGEMENT UP TO AND INCLUDING 200 AMP, 120/240 VOLT

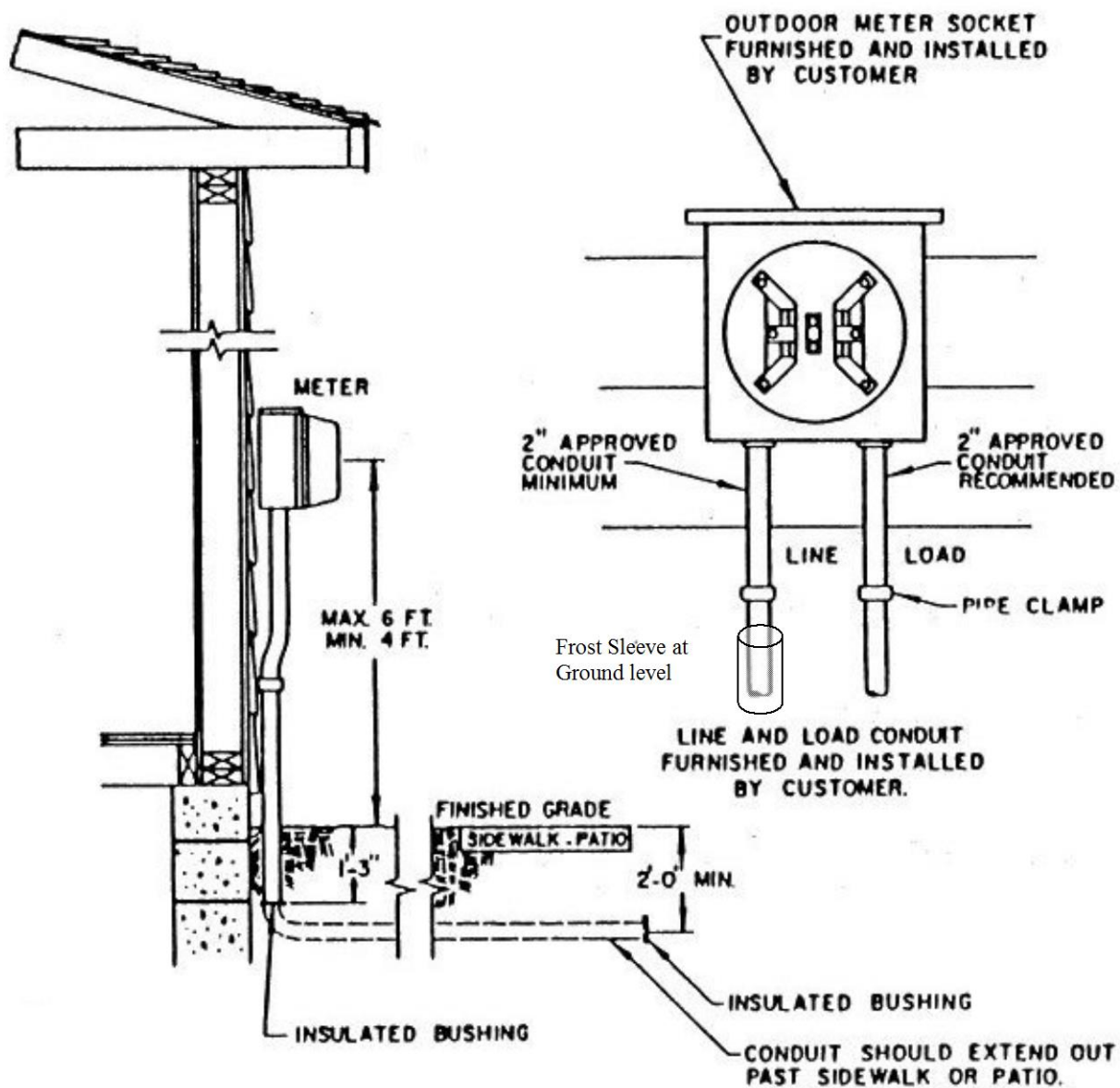
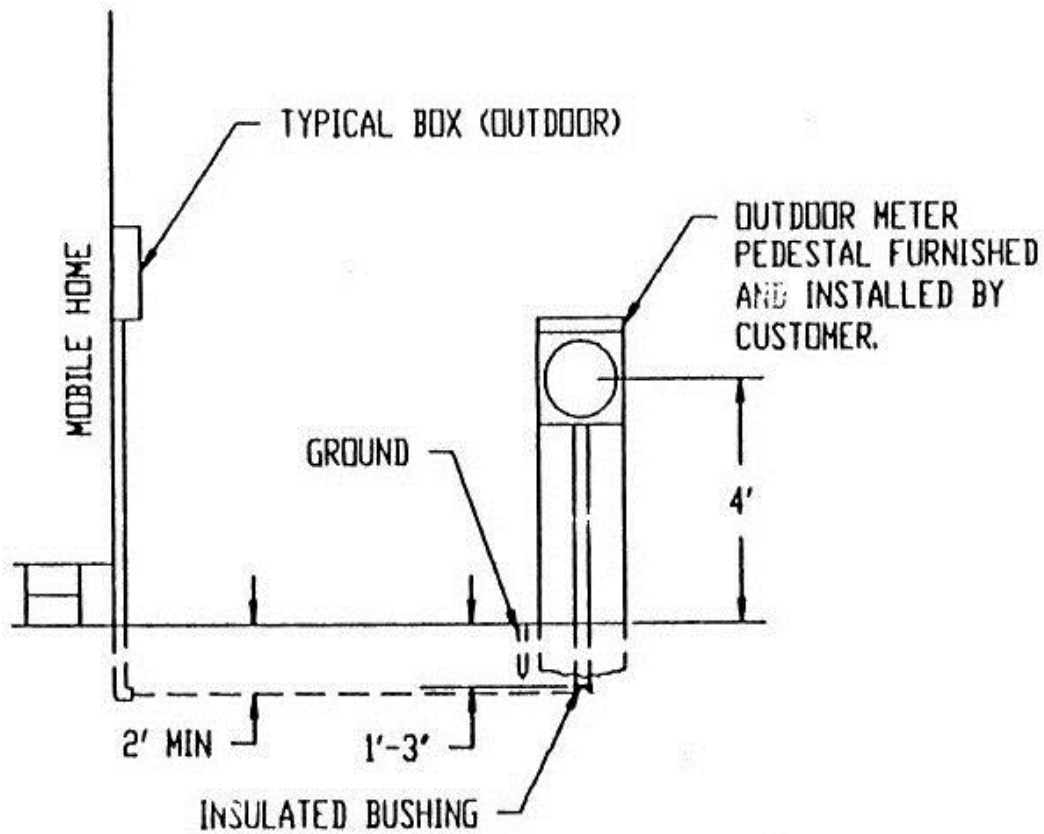

EXHIBIT 2 TYPICAL MOBILE HOME METERING ARRANGEMENT



1. METERS ARE TO BE PERMANENTLY LABELED.
2. METERS ARE TO FACE TOWARDS STREET.
3. SERVICE LATERAL FROM THE SECONDARY JUNCTION AT THE PROPERTY LINE, TO THE METER PEDESTAL, TO THE MOBILE HOME, IS THE RESPONSIBILITY OF THE CUSTOMER.

EXHIBIT 3

TYPICAL MULTIPLE METERING ARRANGEMENT

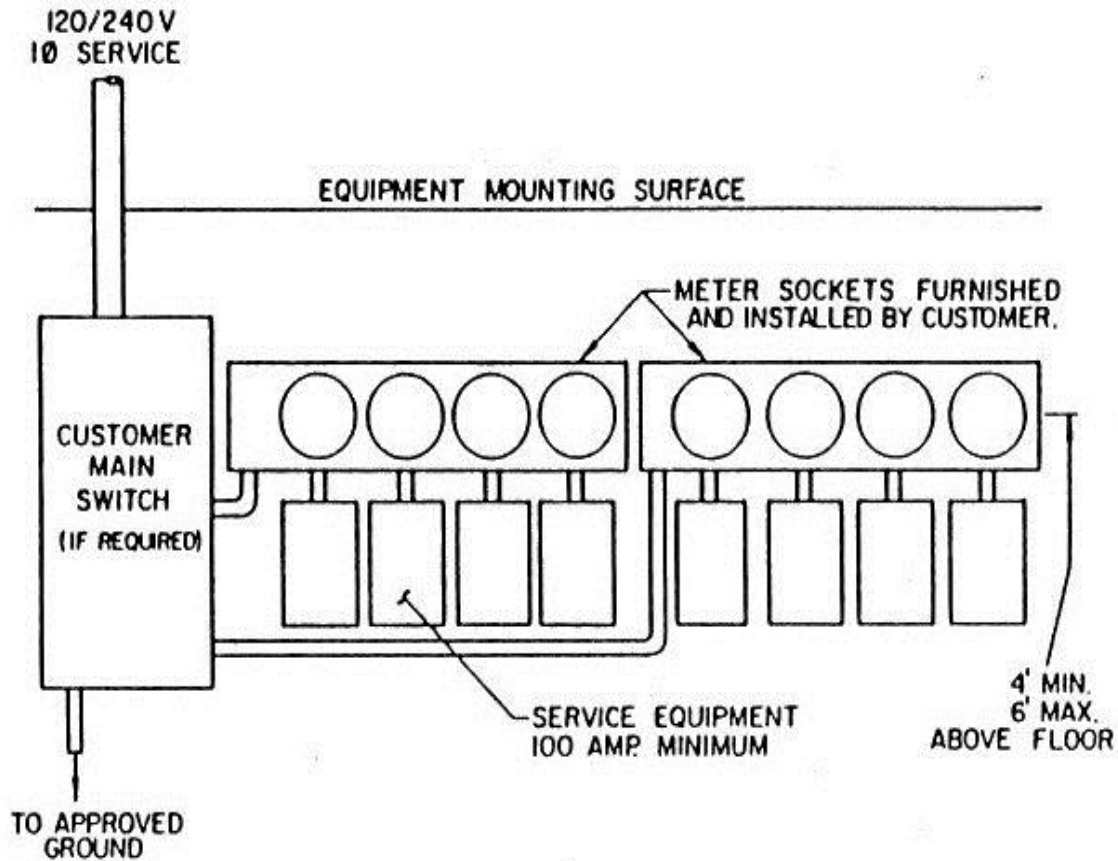

1. METERS ARE TO BE PERMANENTLY LABELED
2. METERS MUST HAVE INDIVIDUAL LOCK-OFF CAPABILITY.
3. METERS MUST BE ACCESSIBLE TO A.U. AND TO CUSTOMERS

EXHIBIT 4

SECONDARY SERVICE DROP CLEARANCES

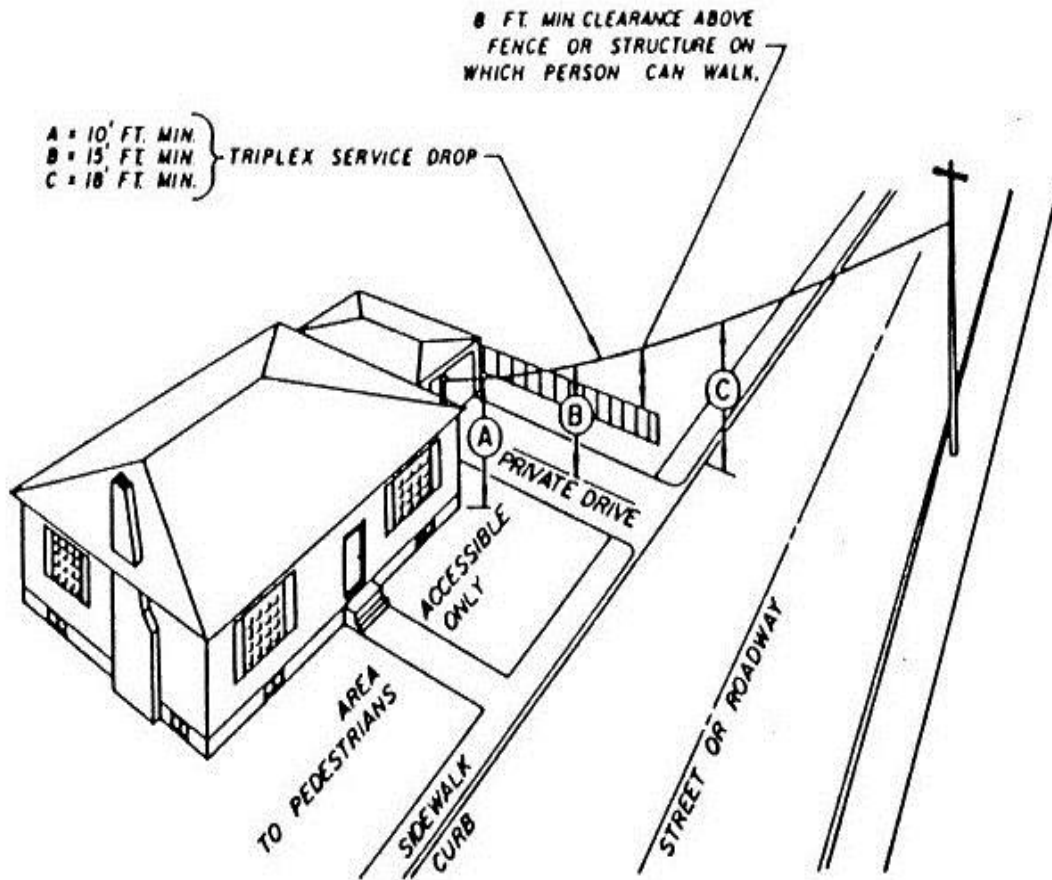

EXHIBIT 5

TYPICAL RESIDENTIAL OVERHEAD SERVICE INSTALLATION

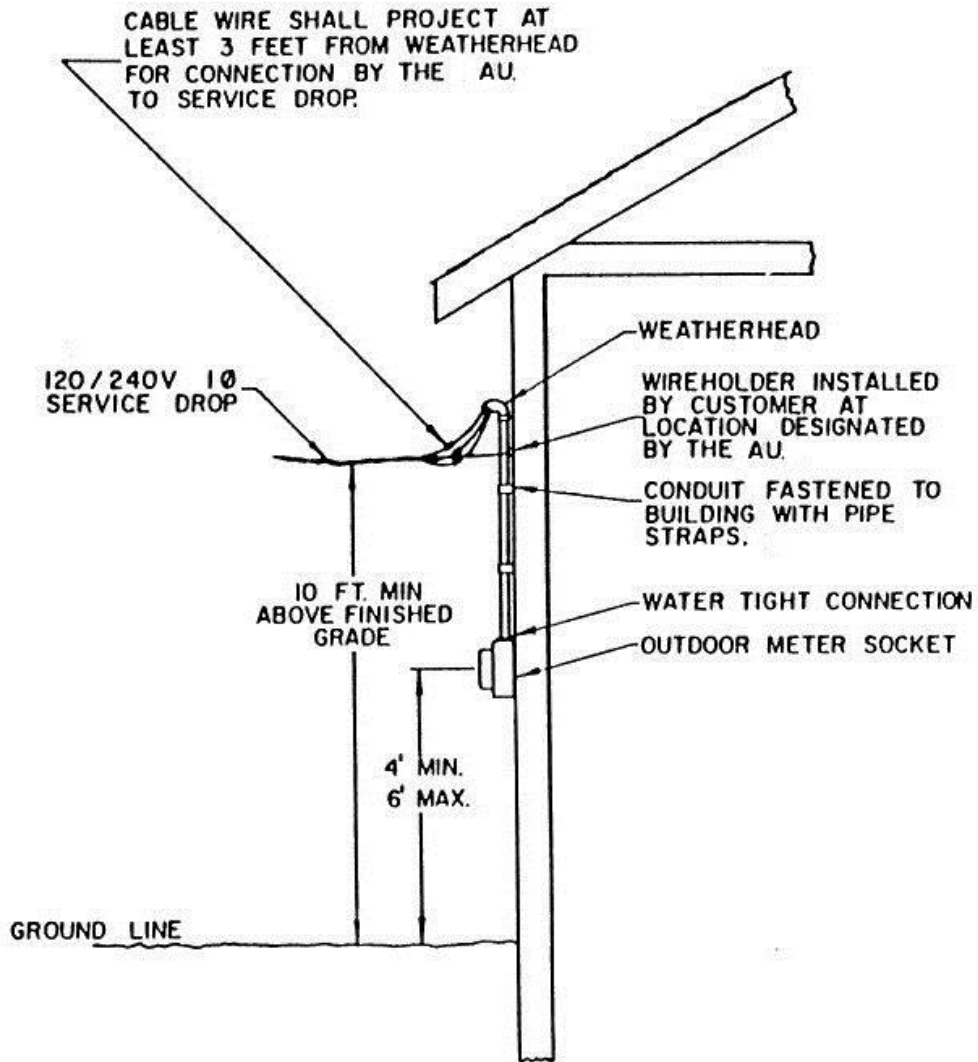

EXHIBIT 6 TYPICAL RESIDENTIAL SERVICE MAST

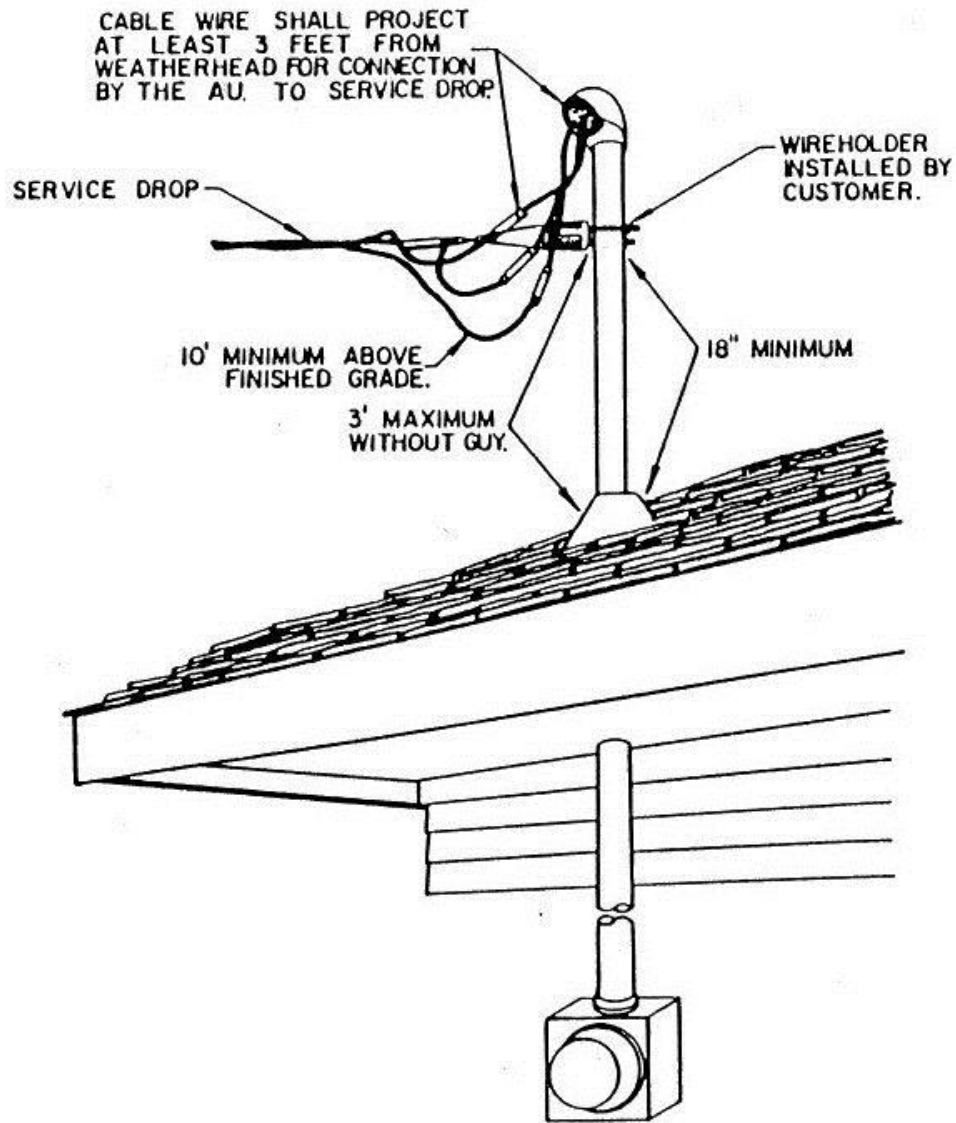

EXHIBIT 7

LOCATION OF PAD-MOUNTED TRANSFORMERS NEAR BUILDINGS

1. **Non-Combustible Walls**

(Included in this class would be wood framed brick veneered buildings, metal clad steel framed buildings, asbestos-cement-board walled metal framed buildings and masonry buildings).

Pad-mounted oil insulated transformers may be located a minimum distance of 24 inches from non-combustible walls if all the following clearances are maintained from doors, windows and other building openings. A sump shall be installed for transformers if the immediate terrain is not pitched away from the building. Contact AU Engineering Section for sump specifications. If a combustible first floor overhang exists, a 10-ft. distance from the edge of the transformer to the edge of the overhang (combination of vertical and horizontal distance) shall be required in addition to the other clearance as shown.

A. **Doors**

Pad-mounted oil insulated transformers shall not be located within a zone extending 20-ft. outward and 10-ft. to either side of a building door.

B. **Air Intake Openings**

Pad-mounted oil transformers shall not be located within a zone extending 10-ft. outward and 10-ft. to either side of an air intake opening located at the level of the transformer. If the air intake opening is located above the transformer level, the distance from the transformer to the opening shall be a minimum of 25-ft.

The above term "level of the transformer" is to be interpreted as within 10-ft. of the ground.

C. **Windows or Openings other than Air Intake**

c1. **First Story**

Pad-mounted oil insulated transformers shall not be located within a zone extending 10-ft. outward and 3-ft. to either side of a building window or opening other than an air intake.

c2. **Second Story**

Pad-mounted oil insulated transformers shall not be located less than 5-ft. from any part of a second story window or opening other than an air intake.

2. **Combustible Walls** (Included in this class would be wood buildings and metal clad buildings with wood frame construction).

Pad-mounted oil insulated transformers shall be located at a minimum of 10-ft. from the building wall. In addition to the clearance from building doors, windows and other openings set forth for non-combustible walls. A sump shall be installed for transformers if the immediate terrain is not pitched away from the building. Contact AU Engineering Section for sump specifications. If a combustible first floor overhang exists, a 10-ft. distance from the edge of the transformer to the edge of the overhang (combination of vertical and horizontal distance) shall be required in addition to the other clearances as shown.

3. Barriers (Included in this class are reinforced concrete, brick or concrete block barrier walls.)

If the clearance specified above cannot be obtained, a fire resistant barrier shall be constructed in lieu of the separation. The barrier when required is provided by the Customer. The following methods of construction are acceptable:

A. Non-Combustible Walls

The barrier shall extend to a projection line from the corner of the pad-mount to the furthest corner of the window, door or opening in question. The height of the barrier shall be 1-ft. above the top of the pad-mounted transformer.

B. Combustible Walls

The barrier shall extend 3-ft. beyond each side of the pad-mounted transformer. The height of the barrier shall be 3-ft. above the top of the pad-mounted transformer. If a combustible first floor overhang exists, the 24-in. specified shall be measured from the edge of the overhang rather than from the building wall.

4. Fire Escapes

Pad-mounted oil insulated transformers shall be located such that a minimum clearance of 20-ft. is maintained from fire escapes at all times.

Exception: Pad-mounted transformers may be located closer to a fire escape than the 20-ft. minimum when a fire resistant barrier is constructed around the pad-mounted (side walls and roof). The barrier shall extend a minimum of 1-ft. beyond the pad-mount. The pad-mount and barrier shall not in any way obstruct the fire escape exit. A 10-ft. clearance is required in front of the pad-mounted transformer doors. Adequate transformer accessibility and ventilation must be provided.

5. Decorative Combustible Enclosure

Decorative combustible enclosures (fence) installed by the customer around pad-mounted transformers adjacent to a combustible building wall shall not extend more than 24-in. beyond the transformer towards the combustible wall. A 10-ft.

clearance is required in front of the pad-mounted transformer doors. Adequate transformer accessibility and ventilation must be provided.

6. Non-Combustible and Combustible Walls – Fire Resistant Barriers

For definitions of combustible and non-combustible walls and fire resistant barriers, refer to the State of Minnesota Building Code.

EXHIBIT 7 (cont'd)

LOCATION OF PAD-MOUNTED TRANSFORMERS NEAR BUILDINGS

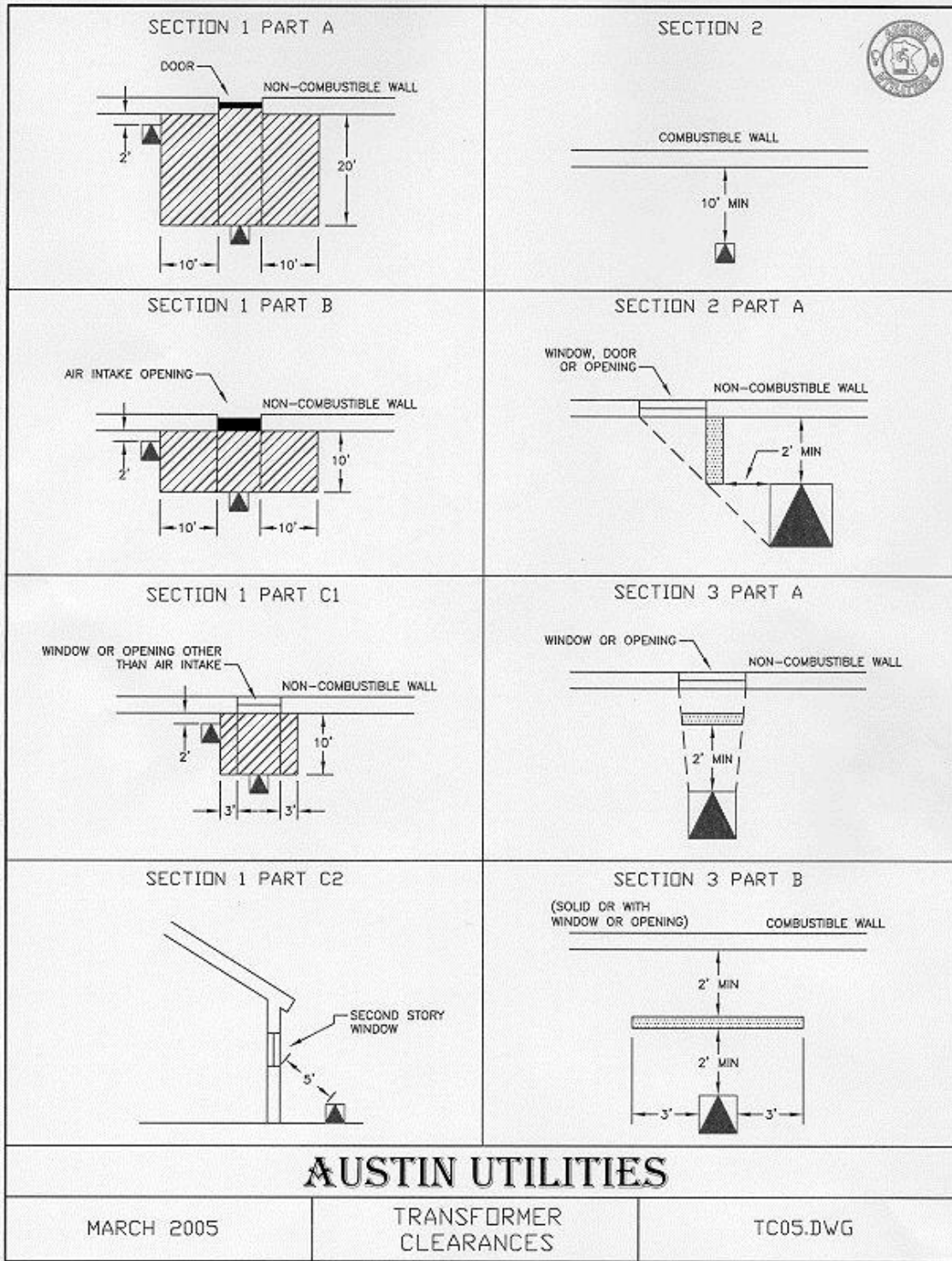

EXHIBIT 8

AU AND CUSTOMER RESPONSIBILITIES ASSOCIATED WITH THREE PHASE INSTALLATIONS

AU Responsibilities

1. Designate service location and/or transformer location.
2. Supply and install pad-mounted transformer.
3. Make all primary terminations and connections.
4. Connect the Customer's secondary cable to the secondary terminals of the transformer only after Customer's wiring has been approved by the inspecting authority.
5. Energize the service only when authorized to do so by the State Electrical Inspector.
6. Supply and install all primary cable to the Customer after said Customer furnishes and installs conduit for the entire distance from the property line to the transformer including a 30-foot vertical riser on the pole, if needed.
7. Supply and install one meter set for each Customer, including all meters required for billing purposes and any accessories such as totalizers, current and potential transformers, phase-shifting transformers, test switches, and color code meter wiring.
8. Inspect customer-furnished equipment required by AU. Installations not in compliance with AU regulations will be rejected.

Customer Responsibilities

1. Contact AU to obtain the location and routing of AU facilities, fill out an "Application for Service," "Electric Service Extension: form, petition and any other forms or statements required by AU.
2. Provide customer contribution to project based on feasibility study prior to start of work.
3. Provide necessary easements and clear area of all construction obstructions.
4. Bring area to final grade before installation of cable and transformers. Grade changes requiring cable adjustments will result in changes to the party requiring the changes.
5. Compaction along conduit route after installation of conduit is Customer's responsibility.
6. Furnish and install a transformer pad, secondary metering compartment, and ground grid to AU' specifications. Contact AU to obtain the pad specifications for the specific service being installed. Notify AU to inspect formed pad and ground grid prior to pouring concrete.

7. Provide the following minimum clearances around the transformer-front -
- 10 feet, sides and back -- 36 inches. These clearances must be at the same grade as the transformer.
8. Provide easy accessibility to area 24 hours a day.
9. Primary duct extensions are to be furnished and installed in 4" Schedule 40 PVC conduit with marker tape to the point of interconnection with AU (36" minimum depth), including steel elbow and 10 feet of steel riser conduit securely attached to the pole. Minimum elbow (bend) radius shall be 36" inches. Furnish and install pull rope in conduit. Secondary duct extensions are to be furnished and installed in Schedule 40 PVC conduit to the point of interconnection with AU, including elbow and Schedule 80 PVC riser system to weather head and securely attached to the pole. Final location of the riser conduit attachment to the pole must be approved by AU personnel.
10. Furnish and install all secondary cables, connectors, cabinets, and conduits from the transformer to the building service entrance.
11. Allow AU to install cable/ conduit prior to installation of sidewalks, curbing, blacktop, topsoil, sprinklers, and lighting along the cable route.
12. Underground installed between November 15 and April 30 will be subject to approval by AU and winter installation charge.
13. Install protective posts if transformer pad is to be installed in parking area or area of vehicular traffic.
14. Protect AU facilities from damage during construction period.
15. Have wiring approved by the State Electrical Inspector and then request service connection by AU.
16. Notify AU prior to any proposed building or grade changes within 10 feet of the electrical service or the cable route.
17. Supply and install AU approved meter socket on outside wall or approved location and install conduit for service cable. Install meter accessories, such as totalizers, current and potential transformers, phase shifting transformers, test switches, and color code meter wiring.
18. Notify AU as far in advance as possible when any unusual loads are anticipated, such as special medical equipment, arc welders, elevators, or any other equipment that could affect AU' system or any other Customer.

EXHIBIT 9

AU AND CUSTOMER RESPONSIBILITIES ASSOCIATED WITH RESIDENTIAL DISTRIBUTION (URD) INSTALLATIONS

AU Responsibilities

1. Designate service location or transformer location.
2. Supply and install all primary cable, transformer pads, and pad mounted transformers.
3. Make all primary terminations and connections and install the grounding system.
4. Supply and install secondary connection pedestals and secondary cable to the pedestals.
5. Connect Customer's secondary cables to AU' secondary terminals after Customer's wiring has been approved by the State Electrical Inspector.
6. Supply and install the meter set, including the meter(s) and any other meter accessories needed for billing purposes, excluding the meter socket.
7. Energize the service only when authorized to do so by the State Electrical Inspector.

Customer Responsibilities

1. Contact AU to obtain the location of AU' facilities and customer service point and to fill out an "Application for Service," and any other forms or statements required by AU.
2. Provide necessary easements and clear area of all construction obstructions.
3. Bring area to final grade before installation of cable and transformers. Install grade stakes at all front lot line property corners. Grade changes requiring cable adjustments will result in charges to the party requiring the changes.
4. New developments, install road-crossing conduits per Section 1500, Exhibit 10, as designation by AU, in the general development specifications.
5. Secondary laterals and secondary feeder duct extensions are to be furnished and installed at the point of interconnection with AU, including Schedule 80 PVC riser to 8 feet and securely attached to the pole.
6. Provide contribution, based on project feasibility analysis to be paid in advance prior to beginning of the construction on the project.
7. Allow AU to install cable/conduit prior to installation of sidewalks, curbing, blacktop, soil, or lighting along cable route.
8. Compaction of Customer installed (buried) cable is Customer's responsibility. (AU will compact all primary and secondary cable it buries).

9. Provide firm soil conditions under the pad area to prevent settling of the pad.
10. Provide the following minimum clearance around the transformer: front-10 feet, sides, and back-36 inches. These clearances must conform to Section 1500, Exhibit 7 and be at the same grade as the transformer.
11. Protect AU facilities from damage during construction period.
12. Provide easy accessibility to the area 24 hours a day.
13. Have wiring approved by State Electrical Inspector and then request a service connection by AU. Provide copy of "Request for Electric Inspection" (REI) to AU.
14. Install protective posts if transformer pad is to be installed in parking area or area of vehicular traffic.
15. Underground cable installed between November 15 and April 30 will be subject to approval by AU and winter installation charge.
16. Notify AU prior to any proposed building or grade changes within 10 feet of the electrical service or the cable route.
17. Notify AU as far in advance as possible when any unusual loads are anticipated, such as special medical equipment, arc welders, elevators, or any other equipment that could affect AU' system or any other Customer.
18. Supply and install AU approved meter socket on outside wall. Customer is to install a minimum 2-inch conduit for the service cable. Service conduit to extend a minimum of 15 inches below grade, an expansion sleeve, and have insulated bushings.
19. Supply and install all secondary cable extending from the meter to the AU designated secondary terminus.
20. Customer to install load management terminals on all air conditioning systems.
21. Contact AU 24 hours in advance when a service is to be installed so that AU can unlock the power source and the Contractor can install the service into the power source.

EXHIBIT 10

DUCT INSTALLATION ROAD CROSSING

EXHIBIT 10

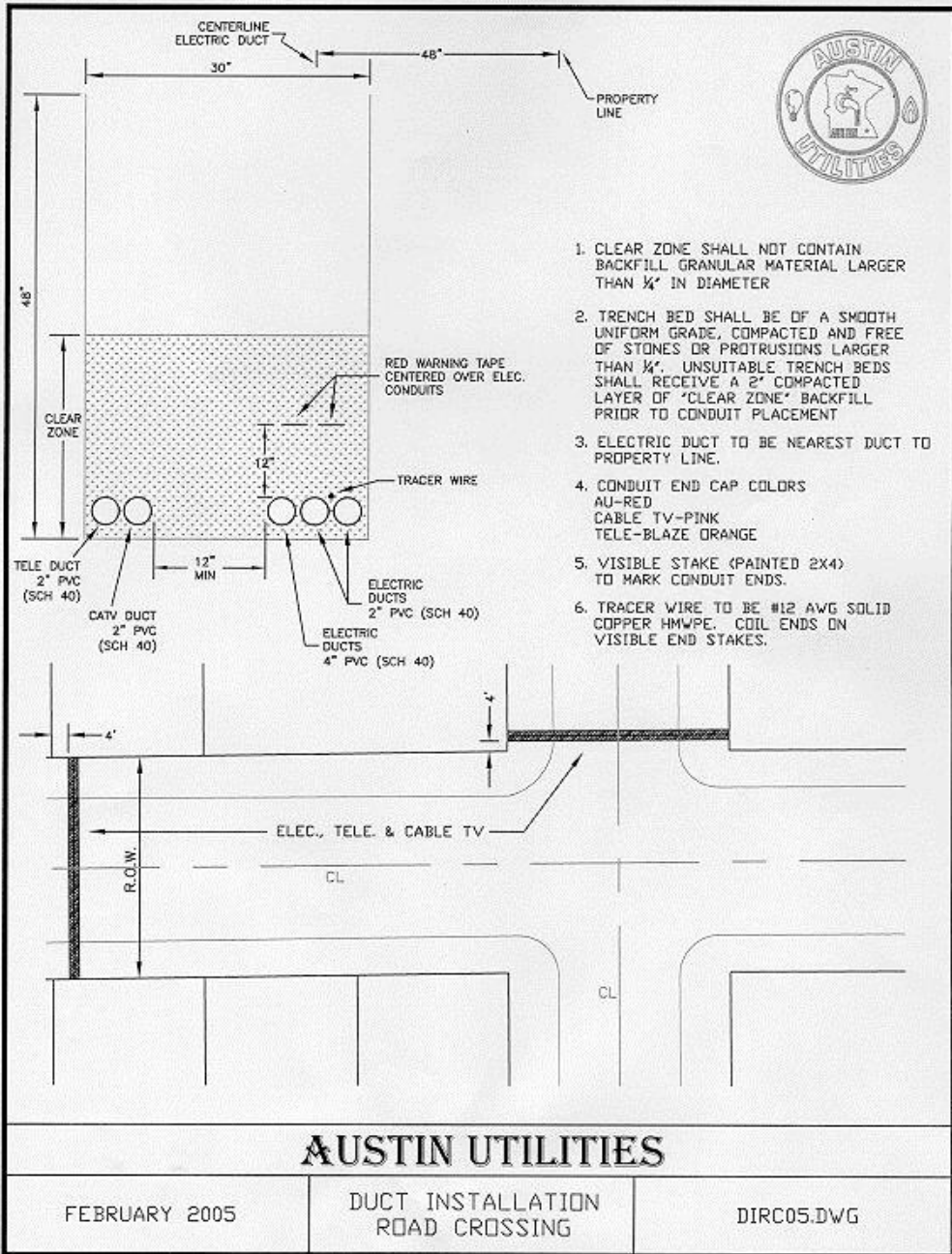

EXHIBIT 11

DUCT INSTALLATION ROAD CROSSING

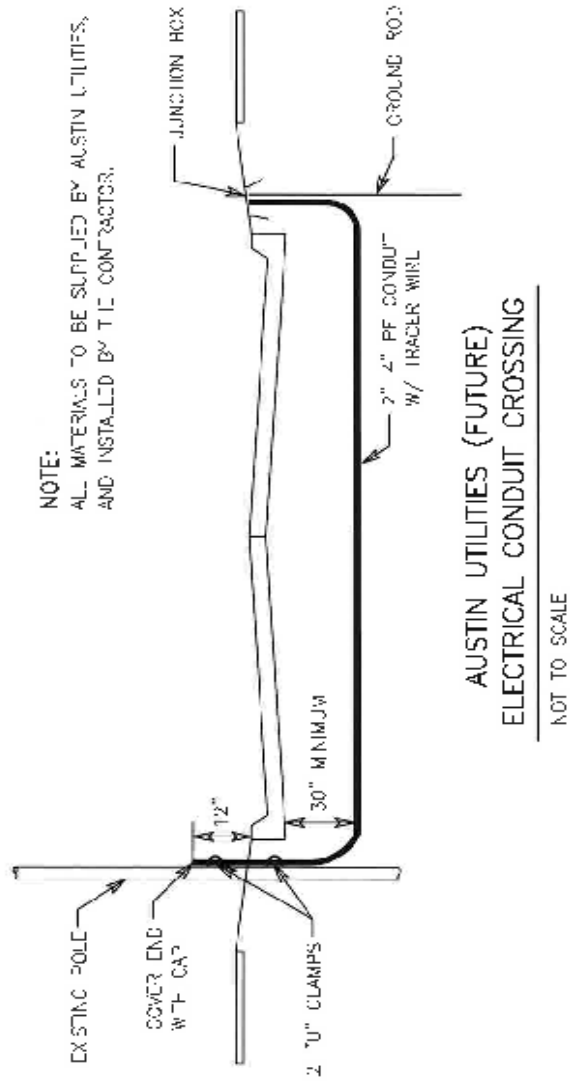

EXHIBIT 12

**AUSTIN UTILITIES
Austin, Minnesota**

AGREEMENT FOR ELECTRIC DISTRIBUTION LINE EXTENSION

The petitioner(s) hereto respectfully represent and state that they are the owners of the lands shown in the description set after their respective name(s). It is requested that electric distribution extension be constructed on the property and/or right of way described below, or such part thereof as you shall deem proper, for domestic or commercial use.

The petitioner(s) shall provide or perform, prior to AU construction of electric facilities:

- 1. Provide plans and information about the development as needed for AU to design and engineer electric facilities.**
- 2. Review, discuss, change as needed, and approve locations of proposed AU electric facilities.**
- 3. Pay to the AU the contribution to cost of service extension.**
- 4. Grant or acquire from others, the necessary easement(s) for electric construction.**
- 5. Provide staking of right-of-way and property lines per AU request.**
- 6. Grade areas where electric construction is proposed to final grade.**
- 7. Water, sanitary sewer, storm sewer, and road crossing duct is installed and marked.**

The petitioner(s) shall meet the following conditions:

- 1. Schedule paving of streets after AU electric construction.**
- 2. Coordinate plans for street lighting with AU and the City of Austin. The petitioner(s) shall hire installation of required street lighting by a licensed electrician at the cost of the petitioner(s).**
- 3. Petitioner(s) and AU will attempt to coordinate installation of electric, telephone, and cable television facilities in a joint trench where possible.**
- 4. Electric service laterals installed by the petitioner's electrician shall be in duct if the development is multi-family residential or commercial.**
- 5. The petitioner(s) shall hire a contractor to replace any pavement at street openings necessary for installation of electric facilities.**
- 6. Protect electric facilities installed from damage during construction of the remainder of the development. Any facilities requiring repair will be billed to the contractor that damaged the facility or the petitioner(s).**

PETITIONERS TO THIS AGREEMENT _____ Date: _____

Name & Address	Addition	Lot	Block	Extension Footage	Extension Cost

EXHIBIT 13

TYPES OF METER SOCKETS

ALL METER SOCKETS WHERE POTENTIAL OR CURRENT TRANSFORMERS ARE NOT REQUIRED MUST BE PURCHASED BY THE HOMEOWNER OR ELECTRICIAN.

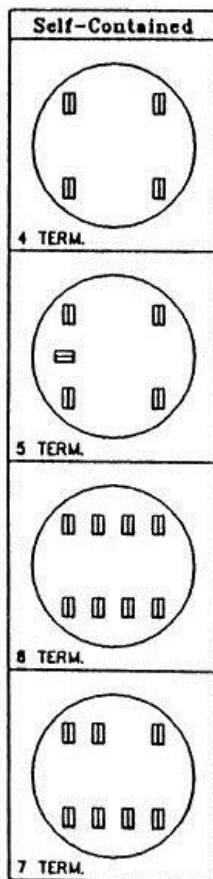

120-240 VOLT SINGLE PHASE.

120-208 VOLT SINGLE PHASE. FIFTH TERMINAL MAY BE LOCATED AT EITHER 9 O'CLOCK OR 6 O'CLOCK POSITION.

120-240 VOLT THREE PHASE THREE WIRE. THIS MUST HAVE A BY-PASS LEVER IN SOCKET.

120-208, 277-480 VOLT THREE PHASE FOUR WIRE. THIS MUST HAVE A BY-PASS LEVER IN SOCKET.
ALSO 240 4 WIRE Δ

EXHIBIT 13 -Continued
TYPES OF METER SOCKETS

ALL SOCKETS REQUIRED FOR USE WITH POTENTIAL OR
CURRENT TRANSFORMERS MUST BE PURCHASED AT  .U.

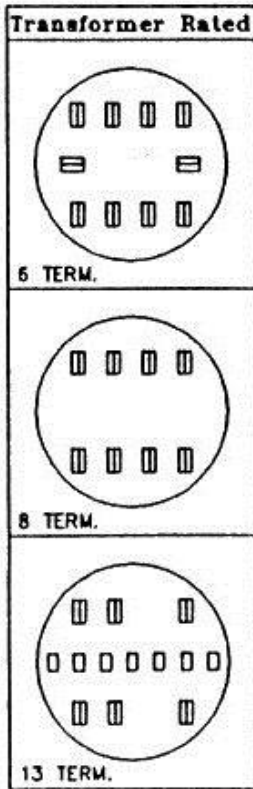
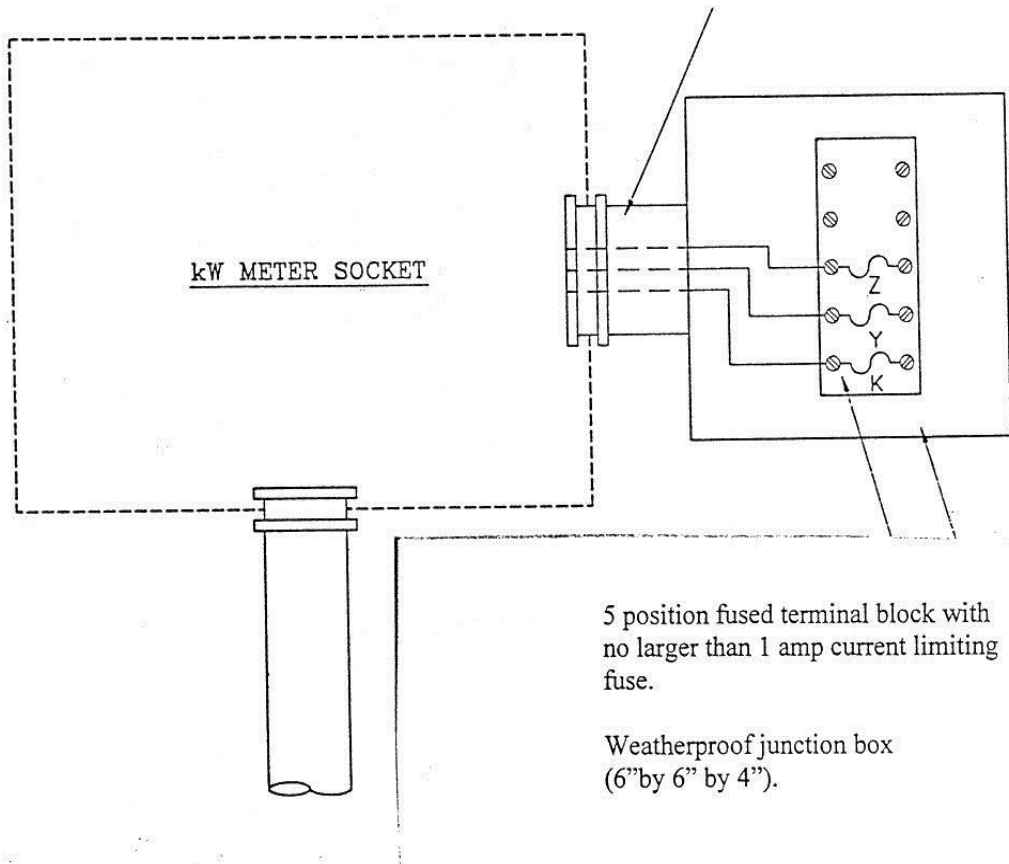

EXHIBIT 14

Load Shedding Customer Connections.

¾" minimum by 2" GRC or EMT nipple with locknuts and bushing.



Notes

Install to NEC.

Equipment furnished and installed by Customer.

KYZ connection on customer terminal strip may vary depending on the customer connections.

LOAD SHEDDING CUSTOMER CONNECTION

EXHIBIT 15

**MULTIPLIERS TO DETERMINE REQUIRED CAPACITOR KVARs
FOR CORRECTING POWER FACTOR**

Original Power Factor	Corrected Power Factor						
	90%	92%	94%	95%	96%	98%	100%
60%	0.849	0.907	.097	1.005	1.042	1.13	1.333
62%	0.781	0.839	0.903	0.937	0.974	1.062	1.265
64%	0.716	0.775	0.838	0.872	0.909	0.998	1.201
66%	0.654	0.712	0.775	0.81	0.847	0.935	1.138
68%	0.594	0.652	0.715	0.75	0.787	0.875	1.078
70%	0.536	0.594	0.657	0.692	0.729	0.817	1.02
72%	0.48	0.538	0.601	0.635	0.672	0.761	0.964
74%	0.425	0.483	0.546	0.58	0.617	0.706	0.909
76%	0.371	0.429	0.492	0.526	0.563	0.652	0.855
78%	0.318	0.376	0.439	0.474	0.511	0.599	0.802
80%	0.266	0.324	0.387	0.421	0.458	0.547	0.75
82%	0.214	0.272	0.335	0.369	0.406	0.495	0.698
84%	0.162	0.22	0.283	0.317	0.354	0.443	0.646
86%	0.109	0.167	0.23	0.265	0.302	0.39	0.593
88%	0.055	0.114	0.117	0.211	0.248	0.337	0.54
90%	0	0.058	0.121	0.156	0.193	0.281	0.484
92%		0	0.063	0.097	0.134	0.223	0.426
94%			0	0.034	0.071	0.16	0.363
96%					0	0.089	0.292
98%						0	0.203
100%							0

INSTRUCTIONS:

1. Determine the average power factor that your system operates at during peak demand months. Call this your ORIGINAL POWER FACTOR.
2. In the row titled CORRECTED POWER FACTOR at the top of the page, find the power factor that you wish to correct your system.
3. Read from left to right along the row corresponding to your ORIGINAL POWER FACTOR until you reach the column that shows your desired CORRECTED POWER FACTOR.

4. Read the number that you find at the intersection of the row and column. Multiply your KW Demand by this number to calculate that total amount of capacitor KVAR you need to install to your electric service.

5. If your plant operates with a 3-phase demand of 410 KW and operates at 76% power factor, but you want to correct to 95%:

a. Find 95% in the CORRECTED POWER FACTOR row at the top of the page.

b. Find 76% in the ORIGINAL POWER FACTOR column along the left edge of the page. Read from left to right along this row until you reach the 95% column.

c. Read the number at the intersection of the row and column (0.526).

$410 \text{ KW} \times .0526 = 216 \text{ KVAR}$ needed to correct your system to 95% power factor.

d. $216 / 3 = 72 \text{ KVAR}$ per phase.

EXHIBIT 17
AU UTILITY THEFT/DIVERSION PROCEDURE

Objective: To provide all personnel and management with a detailed procedure when utility theft has been reported.

- Requirements:
- A) The meter department will investigate all reports of power theft within 24 hours.
 - B) Meter department personnel will determine if the reported theft is clear and evident.
 - C) All utility theft cases that are deemed clear and evident will immediately be turned over to the authorities for investigation and prosecution.
 - D) AU will administer a zero tolerance program for utility theft. (Utility theft is a felony!)

- Content:
- A) Dispatch a meter department personnel to determine if it is a clear and evident utility theft problem.
 - 1) Clear and evident utility theft
 - a) jumpered or unauthorized non-metered services
 - b) spliced or tapped wiring ahead of the meter
 - c) a stolen or tampered meter being utilized
 - B) Upon determination of utility theft contact the Credit Manager or Electric Department Supervisor.
 - C) The Credit Manager or Electric Department Supervisor will notify the appropriate authorities for immediate response. Also, at this time, notify a line crew if needed.
 - D) Meter department personnel will remain at the scene to:
 - 1) Document all information possible
 - 2) Take pictures of utility theft, metering, etc.
 - 3) Assist authorities with investigation
 - 4) Remove and retain any equipment, meters, jumpers, etc. for further prosecution.
 - E) Power theft situations that are reported or found after normal working hours will be handled the following workday.

Date: _____

Approved: _____

EXHIBIT 18

THREE PHASE TRANSFORMER CONCRETE PADS

Austin Utilities Electric Distribution
 Scale: None Tom Tylutki
 433-8886
 Typical Pad Sketch January-04

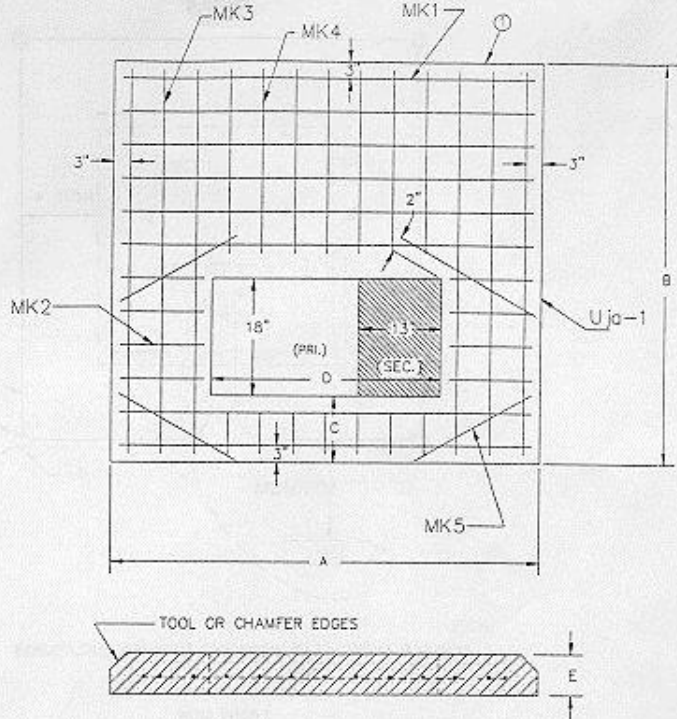

PAD	3-PHASE TRANSF. kVA	DIMENSIONS IN INCHES					REINFORCING BARS				
		A	B	C	D	E	MK1	MK2	MK3	MK4	MK5
#1	75, 112 1/2, 150, 225, 300, 500	76	62	10	42	6	7 #4 70"	4 #4 10"	6 #4 57"	6 #4 28"	4 #4 26"
#2	750, 1000, 1500, 2500	104	100	10	54	8	12 #4 98"	6 #4 19"	6 #4 94"	7 #4 66"	4 #4 29"

NOTES:

1. CONCRETE TESTING, 3000 POUNDS MIN. PER SQUARE INCH; 4% TO 6% ENTRAINED AIR, 3/4" MAXIMUM SIZE AGGREGATE.
2. REINFORCING STEEL, ATSM-A615 GRADE 60, PLACE APPROX. 8" O.C. EACH WAY AND SECURELY TIED TOGETHER.
3. MINIMUM CONCRETE COVER OVER REINFORCING STEEL 2 INCHES UNLESS NOTED.
4. WOOD FLOAT FINISH, LEAVING NO DEPRESSIONS.
5. Secondary duct no higher than top of pad.
6. Traffic ballards required.
7. Maintain 10' clearance from door openings.

THREE PHASE TRANSFORMER CONCRETE PADS	
2000	UM1-6C

EXHIBIT 19

GROUNDING GRID FOR PAD MOUNTED EQUIPMENT INSTALLATION

Austin Utilities Electric Distribution Scale: None Typical Pad Sketch Tom Tyuluki 433-8886 January-04																
<p>NOTE: CONNECT ANODE LEAD INSIDE PAD MOUNTED ENCLOSURES FOR TESTING PURPOSES.</p>																
<p>NOTES:</p> <ol style="list-style-type: none"> 1. PLACE ONE GROUND ROD AT EACH CORNER. 2. GROUNDING GRID 1/0 BARE COPPER BURIED 6" BELOW GROUND, RUN WIRE INTO BASEMENT AND ALLOW 5'-0" FOR GROUNDING LIVE FRONT SWITCH / FUSE ENCLOSURES. 3. PAD OR BASEMENT IS NOT PART OF THIS UNIT. 4. PLACE GROUND WIRE A MINIMUM OF 24" AWAY FROM THE SIDE OR SIDES OF PAD THAT A PERSON WOULD STAND TO OPERATE THE EQUIPMENT. THE GROUND WIRE MAY BE PLACED WITHIN 12" OF THE OTHER SIDES. 5. SPECIFY LENGTH OF GROUND RODS AT EACH CORNER. 																
<table border="1" style="width: 100%; border-collapse: collapse;"> <thead> <tr> <th>ITEM</th> <th>QTY.</th> <th>MATERIAL</th> </tr> </thead> <tbody> <tr> <td>GV</td> <td></td> <td>1/0 bare copper (as required) 30'-0" Min.</td> </tr> <tr> <td>p</td> <td></td> <td>Connectors (as required)</td> </tr> <tr> <td>ai</td> <td>4</td> <td>Ground rods</td> </tr> <tr> <td>aj</td> <td>4</td> <td>Clamp, ground rod, 1 per rod</td> </tr> </tbody> </table>	ITEM	QTY.	MATERIAL	GV		1/0 bare copper (as required) 30'-0" Min.	p		Connectors (as required)	ai	4	Ground rods	aj	4	Clamp, ground rod, 1 per rod	<p>GROUNDING GRID FOR PAD MOUNTED EQUIPMENT INSTALLATION</p> <p>2000 UM4B-5</p>
ITEM	QTY.	MATERIAL														
GV		1/0 bare copper (as required) 30'-0" Min.														
p		Connectors (as required)														
ai	4	Ground rods														
aj	4	Clamp, ground rod, 1 per rod														

EXHIBIT 20

AU SECONDARY METERING COMPARTMENT GROUNDING

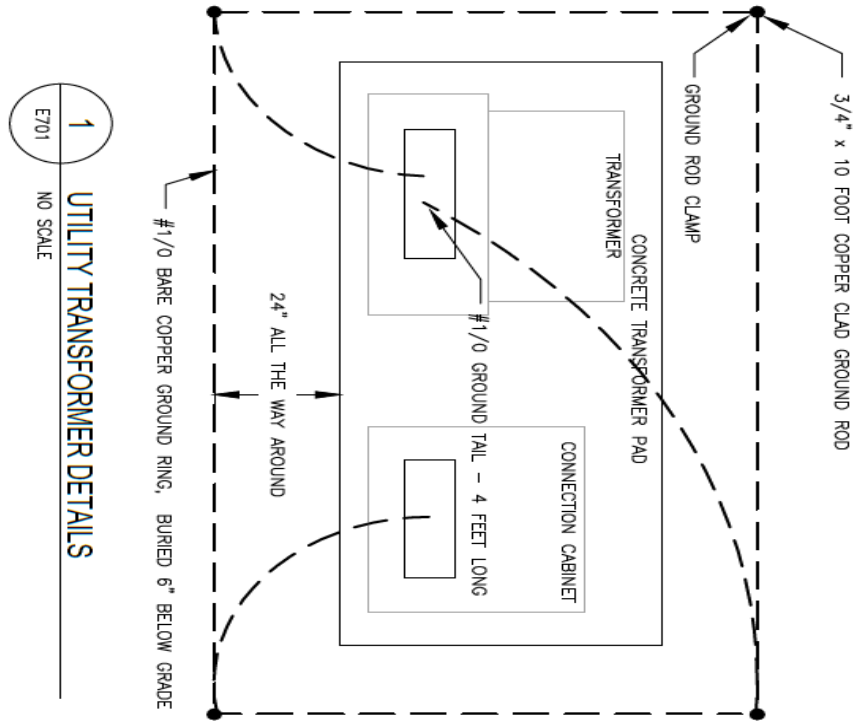

AUSTIN UTILITIES METERING NOTES:

- METER SOCKET PURCHASED AND INSTALLED BY ELECTRICAL CONTRACTOR
- UTILITY METERING CT'S SUPPLIED BY AUSTIN UTILITIES AND INSTALLED BY ELECTRICAL CONTRACTOR.
- EMPTY 1" UNDERGROUND CONDUIT FROM CONNECTION CABINET TO MAIN ELECTRICAL ROOM FOR FUTURE LV METERING CABLE.
- UTILITY METER AND METER WIRING BY AUSTIN UTILITIES.

EXHIBIT 21

MAXIMUM FAULT CURRENTS

Developed at secondary terminals of pad-mounted transformers.

Size of transformer kVA 3Ø	208Y/120 volt 3Ø-4 wire service Phase to ground equals 3Ø fault amps	240/120V closed delta 3Ø-4 wire service		480Y/277 volt 3Ø--4 wire service Phase to ground equals 3Ø fault amps	Size of transformer kVA 1Ø	120/240 volt 1Ø-3 wire service	
		3Ø fault Amps	Ø to ground amps			Ø to ground fault amps	Ø to ground fault amps
45	9,600	7,700	6,100	4,200	15	4,500	4,900
75	18,700	12,000	10,100	6,900	25	7,500	8,100
112.5	22,000	19,100	15,100	10,300	37	11,100	12,200
150	33,900	25,300	20,100	13,600	50	14,800	16,300
225	43,300	37,500	30,200	20,200	75	22,100	24,400
300	57,100	49,500	40,200	26,600	100	29,400	32,600
500	81,800	80,300	67,000	40,200	167	48,600	54,400
750	38,100	33,000	35,300	16,600			
1,000	50,400	43,700	47,200	21,900			
1,500				32,200			
2,000				42,200			

Notes

- All ampere values are symmetrical RMS values.
- For transformers larger than 2,000 kVA-3Ø or 167 kVA-1Ø, consult Austin Utilities for fault values.
- Transformer impedances are actual worst-case (highest fault value) figures. Although the actual fault level at any one time at a customer's installation may be lower than that shown here, replacement equipment installed will likely not have the same impedance as the original transformer, which could result in a higher fault level.
- All fault values are at the transformer secondary terminals. Actual secondary conductor impedance between transformer and customer's main breaker may be used to calculate a lower level at the customer's equipment.
- Residential customers wired for 100 or 200 ampere services in individual homes, townhouses or mobile homes for which a service drop is from an overhead distribution system or a service lateral is from an underground distribution system should have overload devices in their service equipment that have an interrupting capacity of 10,000 amperes.

EXHIBIT 22 METER SOCKET WIRING

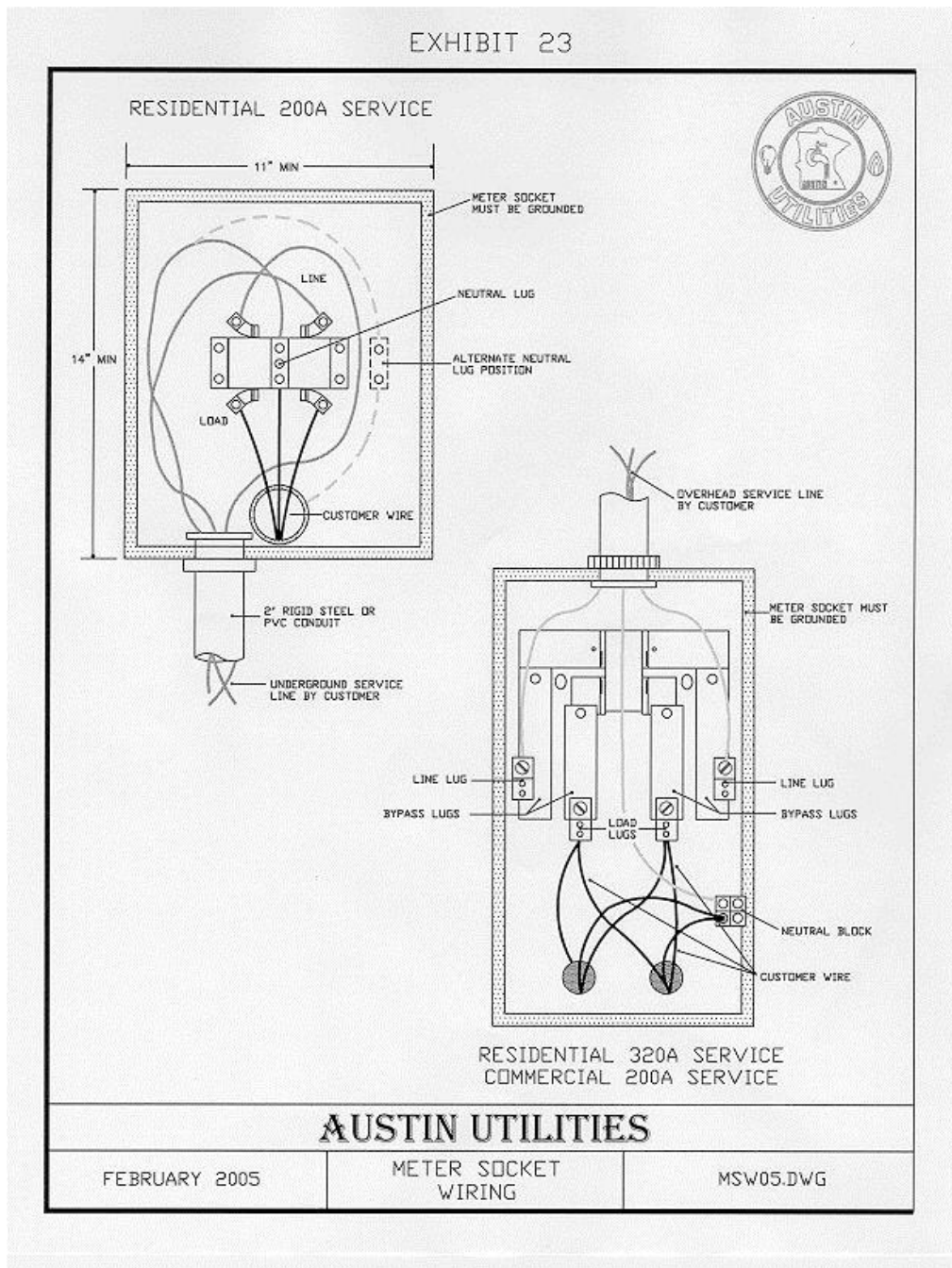

PHONE NUMBERS

General Information	433-8886
Customer Service	437-0855
Bill Payment and Collections	434-0447
Outages (24-Hours)	433-8886
Electric Department	437-0857 437-0834
Underground Location Assistance	
One-Call	1-800-252-1166
Austin Utilities Fax	507-433-5045
Austin Utilities Web Page	www.austinutilities.com

Austin Utilities
1908 14TH Street NE
Austin, Minnesota 55912-3495